



## WHY CHOOSE A KOLPA SAN SHOWER TRAY?

WARUM SIE EINE KOLPA SAN DUSCHWANNE AUSWÄHLEN SOLLTEN?

POURQUOI CHOISIR LE BAC DE DOUCHE KOLPA SAN?

ПОЧЕМУ СЛЕДУЕТ ОСТАНОВИТЬСЯ НА ВЫБОРЕ ДУША KOLPA SAN?



- A selection of different quality classes and materials (Kerrock, cast marble, Marmosan or cast acrylic)
  - Ergonomic form with pure geometric lines and low edge
  - High-flow central **90** mm drain enables freedom of movement during use
  - Our products can be installed in **4** different ways according to the floor preparation (tiled surround wall or acrylic panel do not require preparation of the floor, installation on the floor or level with the floor require preparation of the floor surface)
  - More than **100** models of shower trays for a variety of bathroom layouts
- Choix entre diverses classes de qualité et matériaux (Kerrock, marbre coulé, Marmosan et acrylique sanitaire coulé)
  - Design ergonomique avec des formes géométriques pures et le bord d'entrée bas
  - Utilisation d'un siphon central  $\varnothing$  **90** du débit efficace, permettant le mouvement libre lors de la douche
  - Nos produits permettent **4** options d'installation, avec et sans préparation préalable du pavé (avec le bord maçonné ou avec le revêtement en acrylique – sans
  - préparation préalable du pavé, et le positionnement sur le plancher et au niveau du sol – avec la préparation préalable du pavé)
  - Plus de **100** modèles de receveurs douche pour équiper tous types de salles de bains
- Die Möglichkeit unter verschiedenen Klassen und Materialien (Kerrock, Gussmarmor und Sanitär-Gussacryl) auszuwählen
  - Ergonomisches Design mit reinen geometrischen Formen und niedriger Oberkante
  - Verwendung eines hohen mittleren Überlaufsiphons mit Phi **90**, dass ungestörtes Bewegen während des Duschens ermöglicht
  - Unsere Produkte ermöglichen **4** verschiedene Montagemöglichkeiten, mit und ohne Pflastervorbereitung (mit gemauertem Rand oder mit Acryl-Beschichtung - ohne Pflastervorbereitung, Montage auf dem Boden und auf Bodenniveau – mit Pflastervorbereitung)
  - mehr als **100** Modelle von Duschkabinen für die Ausstattung von verschiedenen Arten von Badezimmern
- возможность выбора между различными качественными классами и материалами (керрок, литой или сантехнический мрамор, литой сантехнический акрил)
  - эргономический дизайн с чистыми геометрическими формами и низкой входной кромкой
  - использование высоко-проточного сифона  $\varnothing$  **90**, обеспечивающего беспрепятственное движение во время принятия душа
  - наши изделия дают возможность **4**-х различных вариантов установки и без предварительного давления (с построенной частью или акриловым покрытием - без предварительного давления, а также установкой на половую поверхность - с предварительным давлением)
  - более **100** моделей душевых ванн для оборудования всех видов ванных комнат

**Accessories**  
Zubehör  
Accessoires  
Аксессуары для  
ванной комнаты

› 282

**Protective paint**  
Schutzanstrich  
Revêtement de protection  
Защитное покрытие

› 295

\* cast sanitary acrylic, gegossenes Sanitäracryl, acrylique moulé sanitaire, литой санитарный акрил  
kerrock, Kerrock, le kerrock, кепрок  
cast marble, Gussmarmor, marbre artificiel, литой мрамор

\*\* modified acrylic, Modifiziertes Acryl, l'acrylique modifié, модифицированный акрил  
composite coat mat, composite coat mat, composite coat mat, цомпосите цоат мат



# SHOWER TRAYS

DUSCHWANNEN  
RECEVEURS DE DOUCHE  
ДУШЕВЫЕ ПОДДОНЫ



## Shower trays - shapes and sizes

Duschwannen - Formen und Maßen

Receveurs de douche - formes et dimensions

Душевые поддоны - таблица форм и размеров

a x b	70	75	80		90			100		105	120	
180			Re-walk 102 Re-walk CCM 102 Flamenco 109									
170		Flamenco 109	Flamenco 109									
160	Flamenco 109		Lavolta 106 Flamenco 109			Lavolta 106 Flamenco 109						
140	Flamenco 109		Re-walk 102 Re-walk CCM 102 Acro 103 Lavolta 106 Serra 108 Flamenco 109			Re-walk 102 Re-walk CCM 102 Acro 103 Canary 105 Lavolta 106 Serra 108 Flamenco 109 Salsa 110						
135										Lolly p018		
130	Flamenco 109		Flamenco 109			Flamenco 109		Malur 115			Milo Tray p010	Boul Tray p006
120			Hora stone 101 Acro 103 Pandora 103 Vals 104 Canary 105 Lavolta 106 Lerock zero 107 Serra 108 Flamenco 109 Salsa 110 Step zero 112 Evelin 114		Malur 115	Hora stone 101 Acro 103 Pandora 103 Vip 104 Vals 104 Canary 105 Lavolta 106 Lerock zero 107 Ramona p014 Serra 108 Flamenco 109 Salsa 110 Step zero 112 Funly 113 Evelin 114						
110			Flamenco 130			Flamenco 109						
100			Hora stone 101 Acro 103 Pandora 103 Canary 105 Flamenco 109 Funly 112		Malur 115	Acro 103 Pandora 103 Flamenco 109			Canary 105 Lavolta 106 Lerock zero 107 Flamenco 109 Rock 111 Step zero 112 Boston 113	Macarena 105 Lavolta 106 Blues 119		
90	Flamenco 109	Canary 105	Flamenco 109			Pandora 103 Canary 105 Lavolta 106 Lerock zero 107 Serra 108 Flamenco 109 Salsa 110 Rock 111 Step zero 112 Boston 113 Evelin 114 Trin 115	Macarena 105 Lavolta 106 Eisa 116 Blues 116 Pony 117 Diva 117 Bebop 118 Evelin 118 Ortex 119					
80			Rock 111 Boston 113 Evelin 114 Trin 115	Pony 117 Evelin 118 Ortex 119								
70	Flamenco 109											



dimensions in cm:

Abmessungen in cm:

dimensions en cm:

размеры в см:



shape: / Form: / forme: / форма:



classical, klassische, classique, классическая



semi-circular, halbrund, demi-circulaire, полукруглая



asymmetrical, asymmetrische, asymétrique, асимметричная



















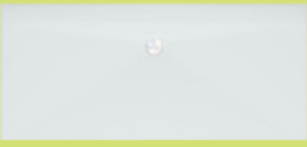
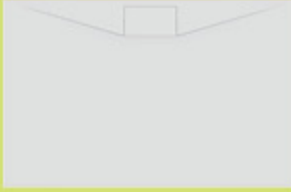
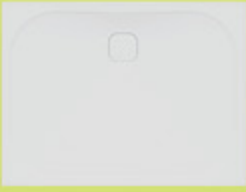

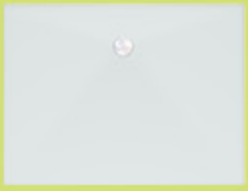

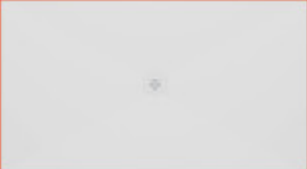

material: / Material: / matériau: / материал:

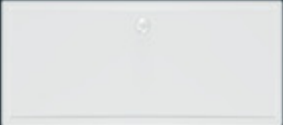
cast sanitary acrylic, gegossenes Sanitäracryl,  
acrylique moulé sanitaire, литой санитарный акрил

kerrock, Kerrock, le kerrock, керрок

cast marble, Gussmarmor, marbre artificiel, литой мрамор

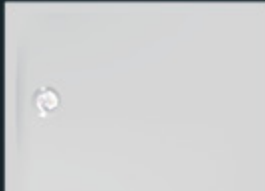
modified acrylic, Modifiziertes Acryl,  
l'acrylique modifié, модифицированный акрил

 <p>Premium</p> <p><b>Shower trays</b> Duschwannen Receveurs de douche Поддоны</p>	 <p>Premium</p> <p><b>BOULTRAY</b> Ø 120 006</p>	 <p>Premium</p> <p><b>MILO TRAY</b> 120x120 010</p>	 <p>Premium</p> <p><b>RAMONA tray</b> 120x90 014</p>
 <p>Premium</p> <p><b>LOLLY tray-L</b> 135x105 018</p>	 <p>Premium</p> <p><b>LOLLY tray-R</b> 135x105 018</p>	 <p><b>Shower trays</b> Duschwannen Receveurs de douche Поддоны</p>	
 <p><b>HORA STONE</b> 120x90, 120x80, 100x80 101</p>	 <p><b>RE-WALK</b> 190x80, 140x80 <b>RE-WALK CCMatt</b> 190x80, 140x80 102</p>	 <p><b>ACRO</b> 140x90, 140x80, 120x90, 120x80, 100x90, 100x80 103</p>	 <p><b>PANDORA tray</b> 120x90, 120x80, 100x90, 100x80, 90x90 103</p>
 <p><b>VIP</b> 120x90 104</p>	 <p><b>VALS</b> 120x90, 120x80 104</p>	 <p><b>CANARY</b> 140x90, 120x90, 120x80, 100x100, 100x80, 90x90, 90x75 105</p>	 <p><b>MACARENA</b> 100x100, 90x90 105</p>
 <p><b>LAVOLTA</b> 160x90, 160x80, 140x90, 140x80, 120x90, 120x80, 100x100, 90x90 106</p>	 <p><b>LAVOLTA</b> 100x100, 90x90 106</p>	 <p><b>LEROCKZERO</b> 120x90, 120x80, 100x100, 90x90 107</p>	 <p><b>SERRA</b> 140x90, 140x80, 120x90, 120x80, 90x90 108</p>
 <p><b>FLAMENCO</b> 180x80, 170x80, 170x75, 160x90, 160x80, 160x70, 140x90, 140x80, 140x70, 130x90, 130x80, 120x100, 120x90, 120x80, 120x70, 110x90, 110x80, 100x100, 100x90, 100x80, 90x90, 90x80, 90x70, 70x70 109</p>	 <p><b>SALSA</b> 140x90, 120x90, 120x80, 100x100, 90x90 110</p>	 <p><b>ROCK</b> 100x100, 90x90, 80x80 111</p>	 <p><b>STEP ZERO</b> 120x90, 120x80, 100x100, 90x90 112</p>
 <p><b>BOSTON</b> 100x100, 90x90, 80x80 113</p>	 <p><b>FUNKY</b> 120x90, 100x80 113</p>	 <p><b>EVELIN tray Q</b> 120x90, 120x80 114</p>	 <p><b>EVELIN tray Q</b> 90x90, 80x80 114</p>



TRIN 90x90, 80x80 115



MALUR-L 120x90, 100x80 115



MALUR-R 120x90, 100x80 115

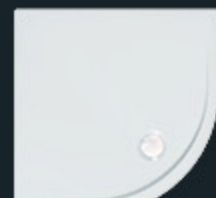

EISA 90x90 116



BLUES 100x100, 90x90 116



PONY 90x90, 80x80 117



DIXIE 90x90 117



BEBOP 90x90 118



EVELIN tray R 90x90, 80x80 118



ONTEX 90x90, 80x80 119

INFO





## Option of installation of shower trays

Möglichkeiten der Montage von Duschwannen

Options d'installation pour les receveurs de douche

Возможности установки поддоны



### a shower tray for built-in installation

Duschwanne für den Einbau

base de douche à installer

Душевой поддон из для установки



### a shower tray for fixing on the floor

Duschwanne zur Bodenaufstellung

base de douche fixer sur le plancher

Душевой поддон из для установки в/на пол



### a shower tray with panel

Duschwanne mit Schürze

base de douche avec revêtement

душевой поддон с панелью



### Installation at the floor level

Einbau auf Bodenniveau

L'installation au fond

встройка на уровне пола

BOUL TRAY FI 120		•		
MILO TRAY 120X120		•		
RAMONA TRAY 120X90	•	•		
LOLLY TRAY-L 135X105		•		
HORA STONE	•	•		
RE-WALK	•	•	•	
RE-WALK CC Matt	•	•		
ACRO	•	•		
PANDORA TRAY	•	•		
VIP	•	•	•	
VALS	•	•	•	
CANARY	•	•	•	
MACARENA	•	•	•	
LAVOLTA	•	•		
LEROCK ZERO				•
SERRA	•	•		
FLAMENCO	•		•	
SALSA	•		•	
ROCK	•		•	
STEP ZERO				•
BOSTON	•		•	
FUNKY	•		•	
EVELIN TRAY Q 120X90, 120x80	•	•	•	
EVELIN TRAY Q 90X90, 80x80	•		•	
TRIN	•		•	
MALUR	•		•	
EISA	•		•	
BLUES	•		•	
PONY	•		•	
DIXIE	•		•	
BEBOP	•		•	
EVELIN TRAY R	•		•	
ONTEX	•		•	







120-219 295

cast marble, Gussmarmor,  
marbre artificiel, литой мрамор



	A	B	H	VM
Hora stone 120 x 90	1200	900	35	35
Hora stone 120 x 80	1200	800	35	35
Hora stone 100 x 80	1000	800	35	35

### Hora stone 120, 100 / Хора стоне 120, 100

- a shower tray for built-in installation or fixing on the floor, made from cast marble, relief surface.
- Duschwanne aus Gussmarmor für den Einbau oder zur Bodenaufstellung, Relief-Oberfläche.
- base de douche à installer ou fixer sur le plancher en marbre coulé, surface en relief.
- душевой поддон из литого мрамора для установки в/на пол с рельефной поверхностью.



white

manhattan

antracit

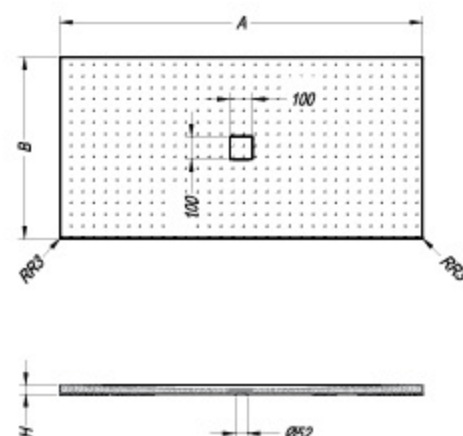
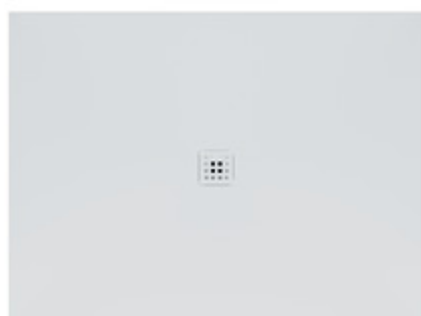
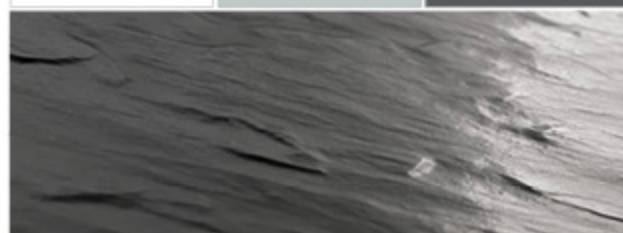



cast marble, Gussmarmor,  
marbre artificiel, литой мрамор



› 120-219 › 295

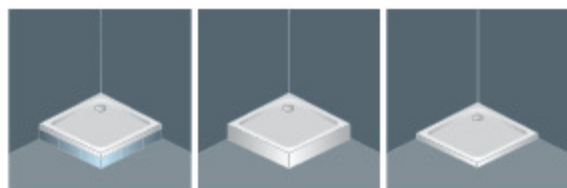

### Re-walk 180x80 (140x70), 140x90 (110x80), 140x80 (110x70)

- a shower tray for built-in installation with a Kerrock panel or fixing on the floor, from cast marble. Possibility of trimming to the specified dimensions.
- Duschwanne aus Gussmarmor für den Einbau, mit Kerrock-Verkleidung, oder zur Bodenaufstellung. Möglichkeit zum Justieren auf die angegebenen Abmessungen.
- base de douche à installer, avec revêtement en Kerrock ou à fixer sur le plancher en marbre coulé. Possibilité de découpe aux dimensions spécifiées
- душевой поддон из литого мрамора для установки в/на пол или установки на ножки/каркас с панелью из kerrock. С возможностью подрезки до указанных размеров.



CCMatt - Composite Coat Matt

cast marble, Gussmarmor,  
marbre artificiel, литой мрамор



› 120-219 › 295

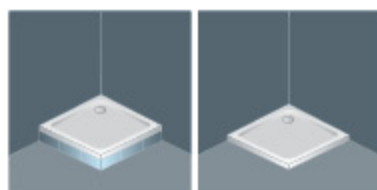

white matt

### Re-walk CCMatt 180x80 (140x70), 140x90 (110x80), 140x80 (110x70)

- a shower tray for built-in installation or fixing on the floor, from cast marble with a matt finish. Possibility of trimming to the specified dimensions.
- Duschwanne aus Gussmarmor für den Einbau, oder zur Bodenaufstellung, mattiert. Möglichkeit zum Justieren auf die angegebenen Abmessungen.
- base de douche à installer ou à fixer sur le plancher en marbre coulé, avec une finition mate. Possibilité de découpe aux dimensions spécifiées
- душевой поддон из литого мрамора для установки в/на пол или установки на ножки, с матовым покрытием. С возможностью подрезки до указанных размеров.

	A	B	VM
Re-walk 180 x 80 (O)	1800	800	155
Re-walk 140 x 90 (O)	1400	900	155
Re-walk 140 x 80 (O)	1400	800	155

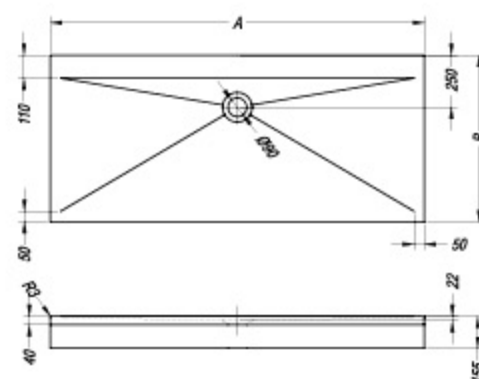
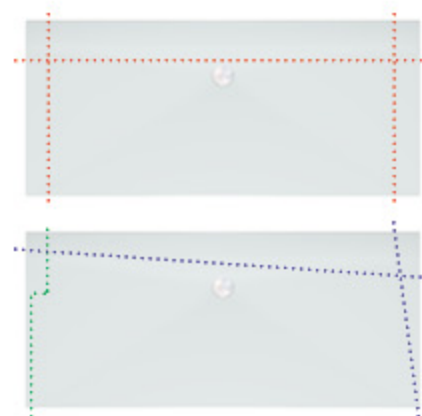

	A	B	VM
Re-walk CCMatt 180 x 80	1800	800	155
Re-walk CCMatt 140 x 90	1400	900	155
Re-walk CCMatt 140 x 80	1400	800	155

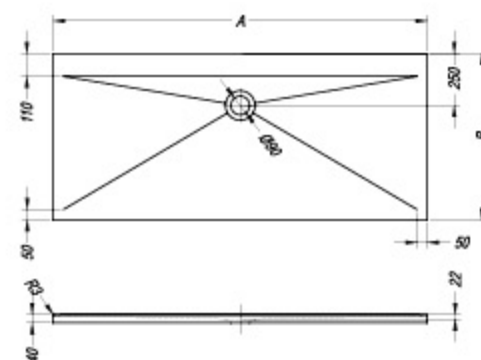



cast marble, Gussmarmor,  
marbre artificiel, литой мрамор



120-219 295

	A	B	VM
Acro 140 x 90	1400	900	35
Acro 140 x 80	1400	800	35
Acro 120 x 90	1200	900	35
Acro 120 x 80	1200	900	35
Acro 100 x 90	1000	900	35
Acro 100 x 80	1000	800	35

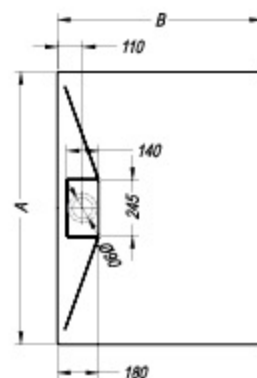

### Acro 140, 120, 100 / Акро 140, 120, 100

- A shower tray for built-in installation or fixing on the floor, made from cast marble
- Duschwanne aus Gussmarmor für den Einbau oder zur Bodenaufstellung
- base de douche à installer ou fixer sur le plancher en marbre coulé
- душевой поддон из литого мрамора для установки в/на пол



cast marble, Gussmarmor,  
marbre artificiel, литой мрамор



120-219 295

	A	B	VM
Pandora tray 120 x 90	1200	900	45
Pandora tray 120 x 80	1200	800	45
Pandora tray 100 x 90	1000	900	45
Pandora tray 100 x 80	1000	800	45
Pandora tray 90 x 90	900	900	45

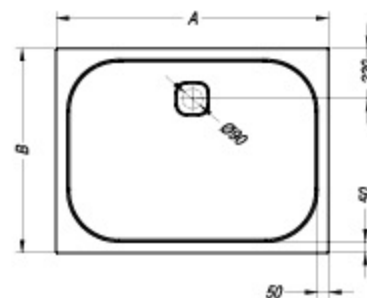
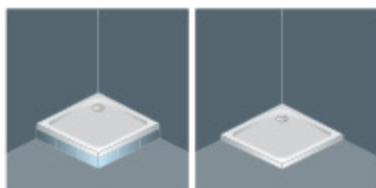

### Pandora tray 120, 100, 90 / Пандора траы 120, 100, 90

- A shower tray for built-in installation or fixing on the floor, made from cast marble
- Duschwanne aus Gussmarmor für den Einbau oder zur Bodenaufstellung
- base de douche à installer ou fixer sur le plancher en marbre coulé
- душевой поддон из литого мрамора для установки в/на пол

cast marble, Gussmarmor,  
marbre artificiel, литой мрамор



	A	B	VM
<b>Vip 120 x 90</b>	1200	900	165

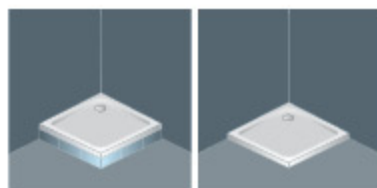

#### Vip 120 / Вип 120

- A shower tray for built-in installation or fixing on the floor, made from cast marble
- Duschwanne aus Gussmarmor für den Einbau oder zur Bodenaufstellung
- base de douche à installer ou fixer sur le plancher en marbre coulé
- душевой поддон из литого мрамора для установки в/на пол



#### Vip 120/O / Вип 120/O

- a shower tray from cast marble with panel
- Duschwanne aus Gussmarmor mit Schürze
- base de douche en marbre coulé avec revêtement
- душевой поддон из литого мрамора с панелью márványból

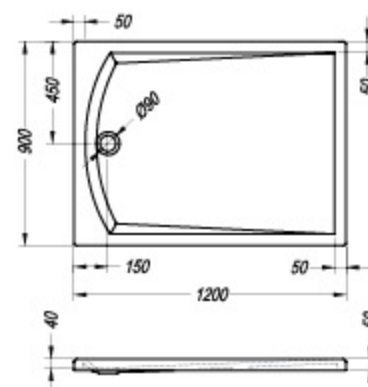

	A	B	VM
<b>Vals 120 x 90</b>	1200	900	155
<b>Vals 120 x 80</b>	1200	800	155

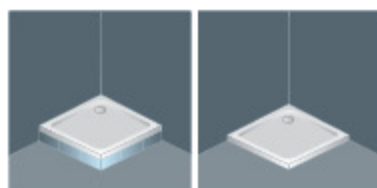

#### Vals 120 / Валс 120

- A shower tray for built-in installation or fixing on the floor, made from cast marble
- Duschwanne aus Gussmarmor für den Einbau oder zur Bodenaufstellung
- base de douche à installer ou fixer sur le plancher en marbre coulé
- душевой поддон из литого мрамора для установки в/на пол



#### Vals 120/O / Валс 120/O

- a shower tray from cast marble with panel
- Duschwanne aus Gussmarmor mit Schürze
- base de douche en marbre coulé avec revêtement
- душевой поддон из литого мрамора с панелью márványból

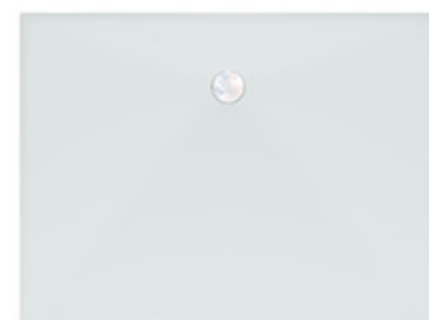
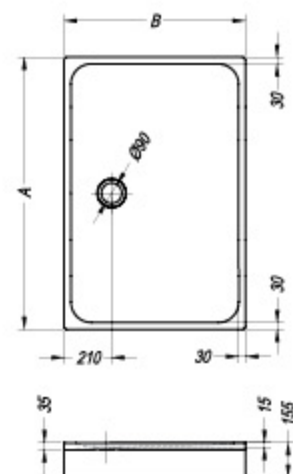

cast marble, Gussmarmor,  
marbre artificiel, литой мрамор

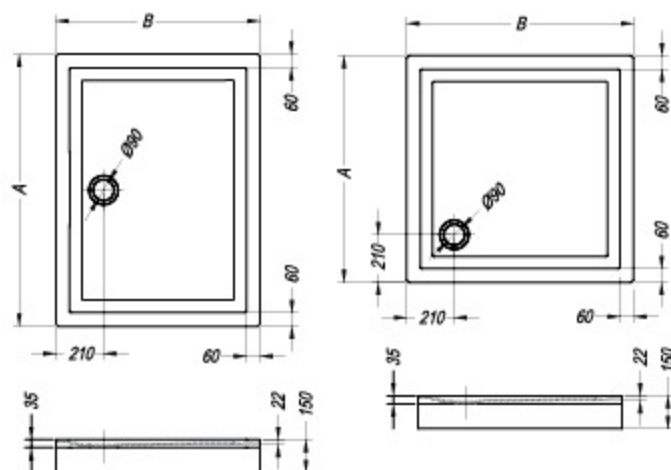

### Canary 140, 120, 100, 90 / Цанары 140, 120, 100, 90

- A shower tray for built-in installation or fixing on the floor, made from cast marble
- Duschwanne aus Gussmarmor für den Einbau oder zur Bodenaufstellung
- base de douche à installer ou fixer sur le plancher en marbre coulé
- душевой поддон из литого мрамора для установки в/на пол

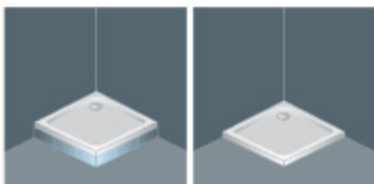

### Canary 140/O, 120/O, 100/O, 90/O / Цанары 140/O, 120/O, 100/O, 90/O

- a shower tray from cast marble with panel
- Duschwanne aus Gussmarmor mit Schürze
- base de douche en marbre coulé avec revêtement
- душевой поддон из литого мрамора с панелью márványból



	A	B	VM
Canary 140 x 90	1400	900	150
Canary 120 x 90	1200	900	150
Canary 120 x 80	1200	800	150
Canary 100 x 100	1000	1000	150
Canary 100 x 80	1000	800	150
Canary 90 x 90	900	900	150
Canary 90 x 75	900	750	150

cast marble, Gussmarmor,  
marbre artificiel, литой мрамор

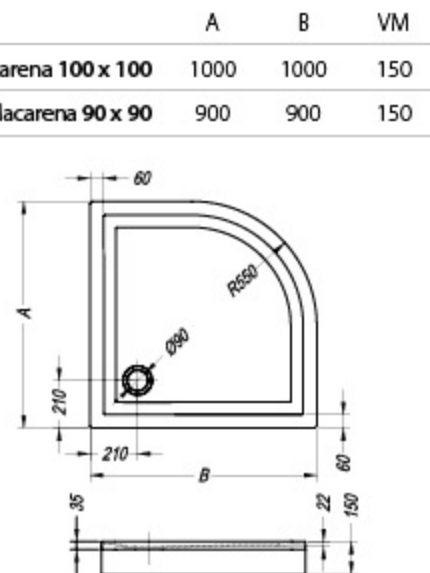

	A	B	VM
Macarena 100 x 100	1000	1000	150
Macarena 90 x 90	900	900	150

### Macarena 100, 90 / Мацарена 100, 90

- a shower tray for built-in installation or fixing on the floor, semi-circular from cast marble
- Duschwanne aus Gussmarmor für den Einbau oder zur Bodenaufstellung
- base de douche à installer ou fixer sur le plancher, semi-circulaire en marbre coulé
- полукруглый душевой поддон из литого мрамора для установки в/на пол



### Macarena 100/O, 90/O / Мацарена 100/O, 90/O

- a shower tray with panel, semi-circular from cast marble
- Duschwanne aus Gussmarmor mit Schürze, halbrund
- base de douche avec revêtement, semi-circulaire en marbre coulé
- полукруглый душевой поддон с панелью из литого мрамора



kerrock, Kerrock,  
le kerrock, керрок

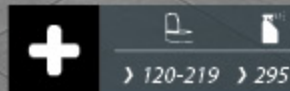

	A	B	C	VM
Lavolta 160 x 90	1600	900	20	40
Lavolta 160 x 80	1600	800	20	40
Lavolta 140 x 90	1400	900	20	40
Lavolta 140 x 80	1400	800	20	40
Lavolta 120 x 90	1200	900	15	40
Lavolta 120 x 80	1200	800	15	40
Lavolta 100 x 100	1000	1000	15	40
Lavolta 90 x 90	900	900	15	40

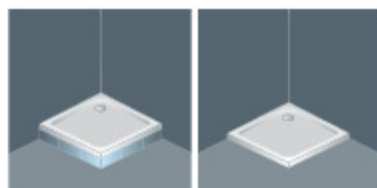

### Lavolta 160, 140, 120, 100, 90 / Лаволта 160, 140, 120, 100, 90

- a shower tray for built-in installation or fixing on the floor, made from Kerrock
- Duschwanne aus Kerrock für den Einbau oder zur Bodenaufstellung
- base de douche à installer ou fixer sur le plancher en Kerrock
- душевой поддон для установки в/на пол из Kerrock

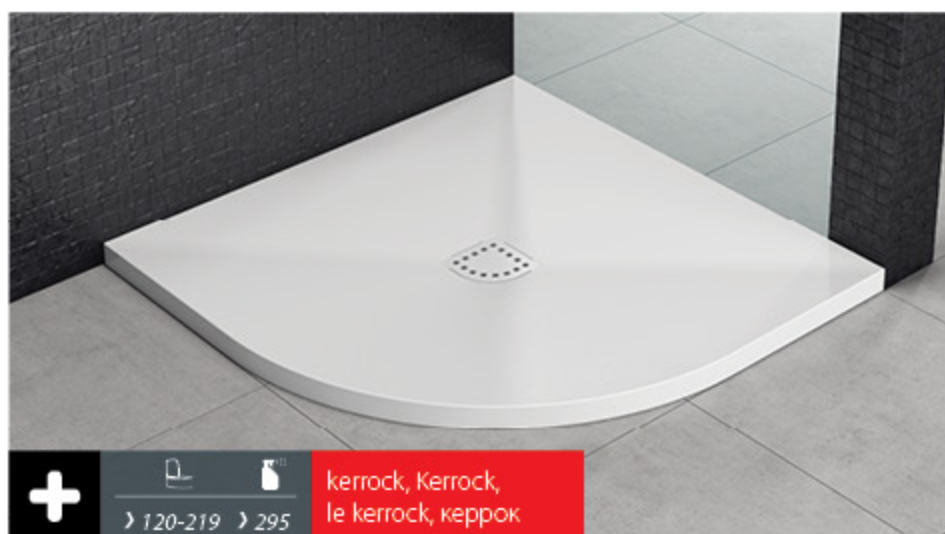
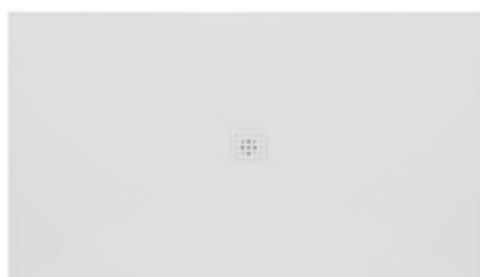
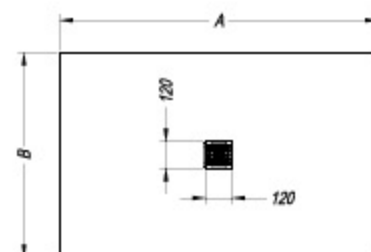

kerrock, Kerrock,  
le kerrock, керрок



### Lavolta 100, 90 R / Лаволта 100, 90 P

- a shower tray for built-in installation or fixing on the floor, semi-circular, made from Kerrock
- Duschwanne aus Kerrock für den Einbau oder zur Bodenaufstellung, halbrund
- base de douche à installer ou fixer sur le plancher, semi-circulaire en Kerrock
- полукруглый душевой поддон установки в/на пол из Kerrock

	A	VM
Lavolta R 100 x 100	1000	40
Lavolta R 90 x 90	900	40

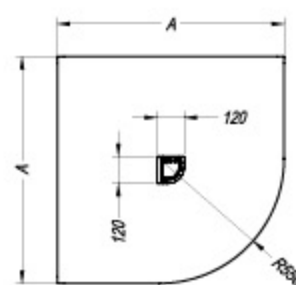



### Lerock ZERO 120, 100, 90 / Лерок ЗЕРО 120, 100, 90

- Kerrock shower tray, shallow bottom, Installation at the floor level, high-flow Ø 52 trap, supporting structure, H = 12mm.
- Duschwanne aus Kerrock, flacher Boden, Bodeneinbau, high-flux Siphon Ø 52, Tragkonstruktion, H = 12mm.
- receveur de douche en Kerrock, très plat, pour installation au fond, siphon à haut débit Ø 52, support, H = 12mm.
- душевой поддон из керрока, с плоским дном, установка на уровне пола, сифон с высокой скоростью потока Ø 52, несущая конструкция, H = 12 мм.

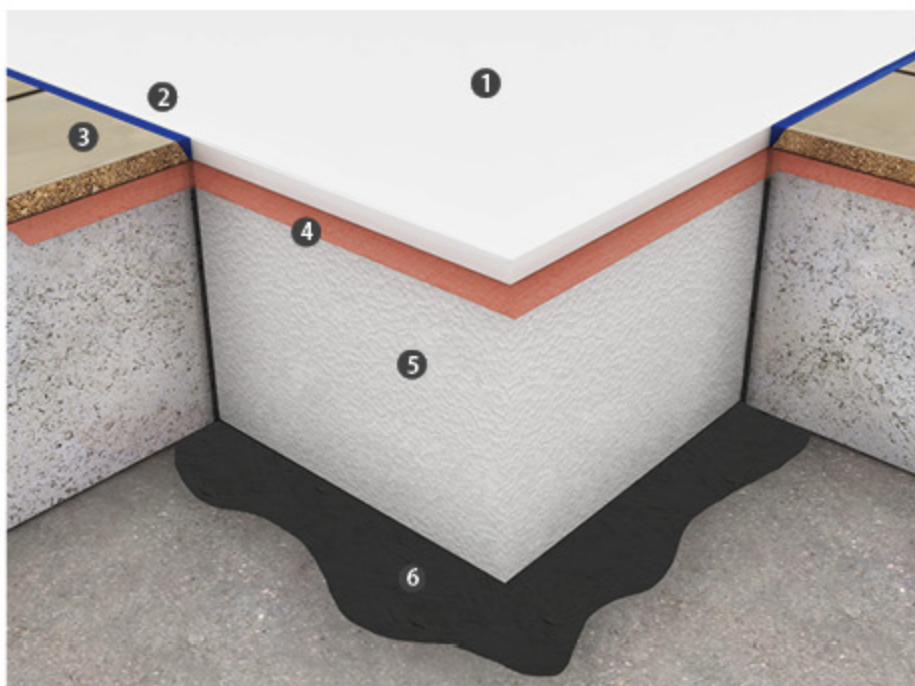
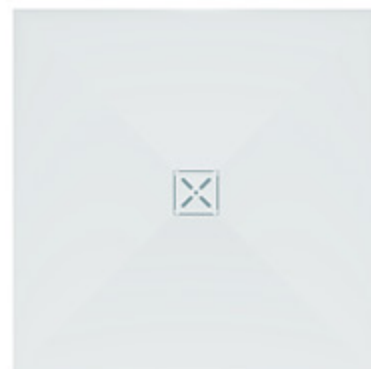
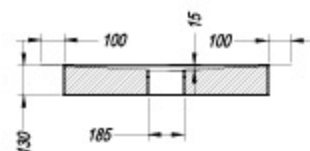
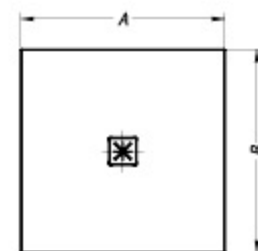

	A	B	VM
Lerock zero 120 x 90	1200	900	130
Lerock zero 120 x 80	1200	800	130
Lerock zero 100 x 100	1000	1000	130
Lerock zero 90 x 90	900	900	130



Installation at the floor level with a height compensation option up to 15 cm max.  
 Einbau auf Bodenniveau, Möglichkeit der Höhenanpassung bis max. 15 cm.  
 L'installation au fond avec la possibilité de compensation de l'hauteur jusqu'à 15 cm max.  
 Встройка на уровне пола, возможность компенсации высоты до макс. 15 см.

- ① - shower tray / Duschwanne / douche baignoire / душевой поддон
- ② - sanitary silicone / Sanitärsilikon / silicone sanitaire / санитарный силикон
- ③ - ceramics / Keramik / céramique / керамика
- ④ - waterproof film / wasserdichte Folie / film imperméable / водонепроницаемая пленка
- ⑤ - polystyrene / Styropor / polystyrène expansé / полистирол
- ⑥ - waterproof coating / wasserdichte Beschichtung / revêtement imperméable / водостойкое покрытие





 modified acrylic, Modifiziertes Acryl,  
 l'acrylique modifié,  
 модифицированный акрил

› 120-219 › 295



	A	B	C	VM
Serra 140 x 90	1400	900	18	45
Serra 140 x 80	1400	800	18	45
Serra 120 x 90	1200	900	18	45
Serra 120 x 80	1200	800	18	45
Serra 90 x 90	900	900	18	45

**Serra 140, 120, 90 /  
Серра 140, 120, 90**

- ashower tray for built-in installation or fixing on the floor, made from modified acrylic, relief surface
- Duschwanne aus modifiziertem Acryl für den Einbau oder zur Bodenaufstellung, Relief-Oberfläche
- base de douche à installer ou fixer sur le plancher en acrylique modifié, surface en relief
- душевой поддон для установки в/на пол из модифицированного акрила с рельефной поверхностью

SERRA 140, 120, 90

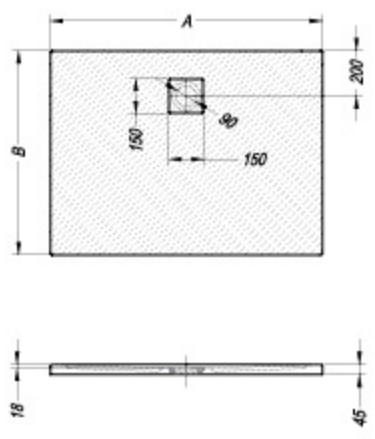
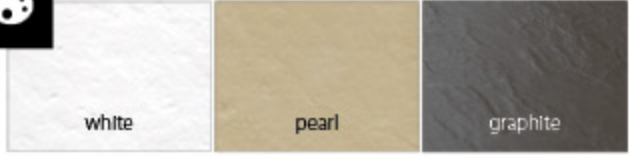



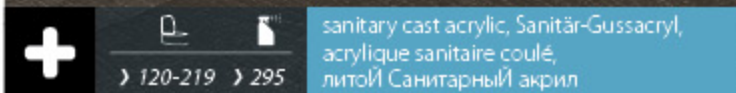

**Flamenco 180, 170, 160, 140, 130, 120, 110, 100, 90, 70 /**

**Фламенко 180, 170, 160, 140, 130, 120, 110, 100, 90, 70**

- a shower tray for built-in installation, made from cast sanitary acrylic
- Duschwanne aus Guss-Sanitäracryl für den Einbau
- base de douche à installer, en acrylique sanitaire coulé
- душевой поддон для установки в/на пол из литого сантехнического акрила



**Flamenco 180/O, 170/O, 160/O, 140/O, 130/O, 120/O, 110/O, 100/O, 90/O, 70/O /**

**Фламенко 180/O, 170/O, 160/O, 140/O, 130/O, 120/O, 110/O, 100/O, 90/O, 70/O**

- a shower tray with panel, made from cast sanitary acrylic
- Duschwanne aus Guss-Sanitäracryl mit Schürze
- base de douche avec revêtement, en acrylique sanitaire coulé
- душевой поддон из литого сантехнического акрила с панелью

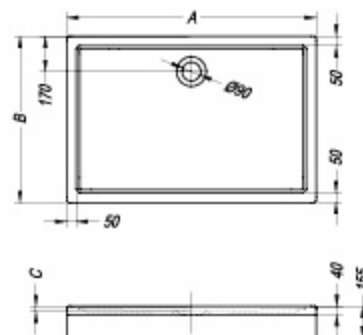

	A	B	C	VM
Flamenco 180 x 80	1800	800	35	155
Flamenco 170 x 80	1700	800	35	155
Flamenco 170 x 75	1700	750	30	155
Flamenco 160 x 90 (80)	1600	900 (800)	35	155
Flamenco 160 x 70	1600	700	30	155
Flamenco 140 x 90 (80/70)	1400	900 (800 / 700)	25	155
Flamenco 130 x 90 (80)	1300	900 (800)	25	155
Flamenco 120 x 100 (90/80/70)	1200	1000 (900 / 800 / 700)	25	155
Flamenco 110 x 90 (80)	1100	900 (800)	25	155
Flamenco 100 x 100	1000	1000	25	155
Flamenco 100 x 90 (80)	1000	900 (800)	25	155
Flamenco 90 x 90	900	900	25	155
Flamenco 90 x 80 (70)	900	800 (700)	25	155
Flamenco 70 x 70	700	700	25	155



› 120-219 › 295

sanitary cast acrylic, Sanitär-Gussacryl,  
acrylique sanitaire coulé,  
литой Санитарный акрил



#### Salsa 140, 120, 90 /

#### Салса 140, 120, 90

- a shower tray for built-in installation, made from cast sanitary acrylic
- Duschwanne aus Guss-Sanitäracryl für den Einbau
- base de douche à installer, en acrylique sanitaire coulé
- душевой поддон для установки в/на пол из литого сантехнического акрила



#### Salsa 140/O, 120/O, 90/O /

#### Салса 140/O, 120/O, 90/O

- a shower tray with panel, made from cast sanitary acrylic
- Duschwanne aus Guss-Sanitäracryl mit Schürze
- base de douche avec revêtement, en acrylique sanitaire coulé
- душевой поддон из литого сантехнического акрила с панелью

	A	B	VM
Salsa 140 x 90	1400	900	140
Salsa 120 x 90	1200	900	140
Salsa 120 x 80	1200	800	140
Salsa 90 x 90	900	900	140

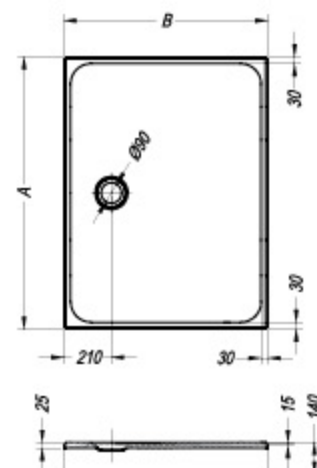
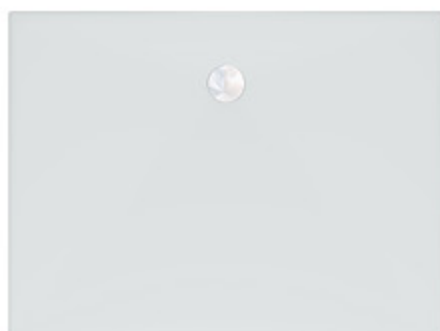



› 120-219 › 295

sanitary cast acrylic, Sanitär-Gussacryl,  
acrylique sanitaire coulé,  
литой Санитарный акрил

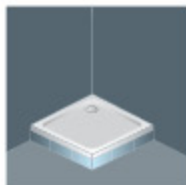

#### Rock 100, 90, 80

#### Рок 100, 90, 80

- a shower tray for built-in installation, made from cast sanitary acrylic
- Duschwanne aus Guss-Sanitäracryl für den Einbau
- base de douche à installer, en acrylique sanitaire coulé
- душевой поддон для установки в/на пол из литого сантехнического акрила



#### Rock 100/O, 90/O, 80/O

#### Рок 100/O, 90/O, 80/O

- a shower tray with panel, made from cast sanitary acrylic
- Duschwanne aus Guss-Sanitäracryl mit Schürze
- base de douche avec revêtement, en acrylique sanitaire coulé
- душевой поддон из литого сантехнического акрила с панелью

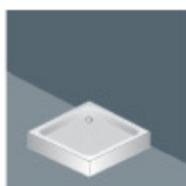

#### Rock 90/30, 80/30

#### Рок 90/30, 80/30

- A shower tray with three-sided panel, made from cast sanitary acrylic
- Duschwanne aus Guss-Sanitäracryl mit dreiseitiger Schürze
- base de douche avec revêtement triangulaire, en acrylique sanitaire coulé
- душевой поддон с трёхсторонней панелью из литого санитарного акрила



	A	VM
Rock 100 x 100	1000	210
Rock 90 x 90	900	210
Rock 80 x 80	800	210

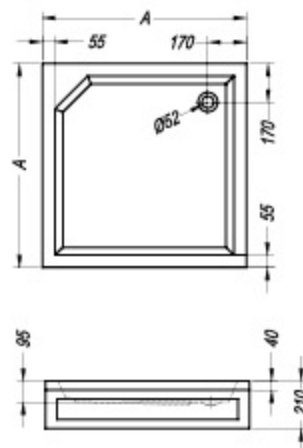



	A	B	VM
Step ZERO 120 x 90	1200	900	130
Step ZERO 120 x 80	1200	800	130
Step ZERO 100 x 100	1000	1000	130
Step ZERO 90 x 90	900	900	130



### Step ZERO 120, 100, 90 / Срен ZERO 120, 100, 90

- shower tray made from sanitary cast acryl, shallow bottom, Installation at the floor level, high-flow Ø 90 trap, supporting structure, H = 15 mm.
- Duschwanne aus Sanitär-Gussacryl, flacher Boden, für den Einbau in den Boden, high-flux Siphon Ø 90, Tragkonstruktion, H = 15 mm.
- receveur de douche en acrylique sanitaire coulé, très plat, pour installation au fond, haut débit siphon Ø 90, support, H = 15 mm.
- душевой поддон из керрока, с плоским дном, установка на уровне пола, сифон с высокой скоростью потока Ø 90, несущая конструкция, H=15 мм.

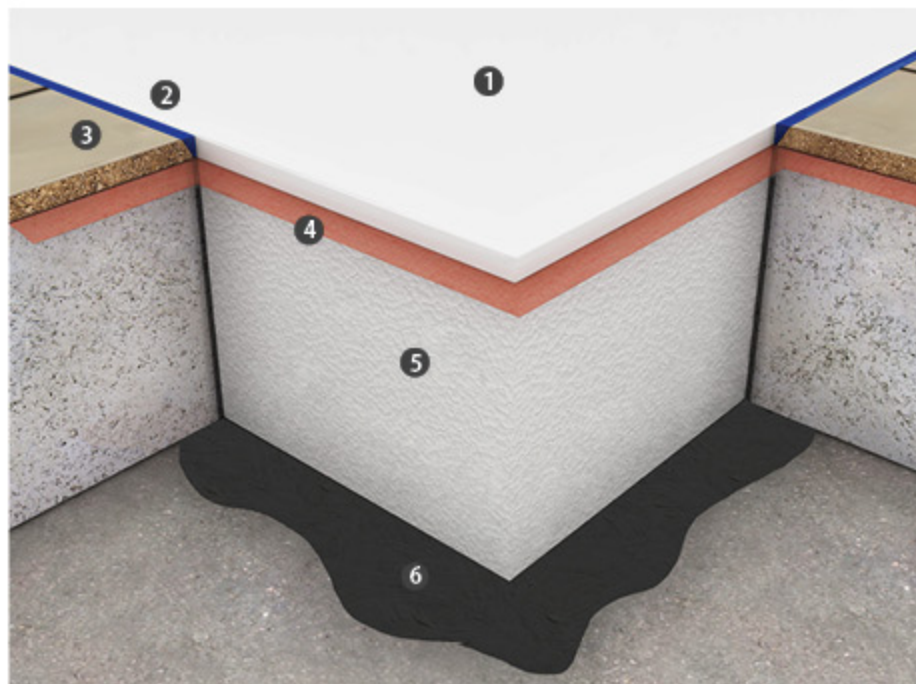
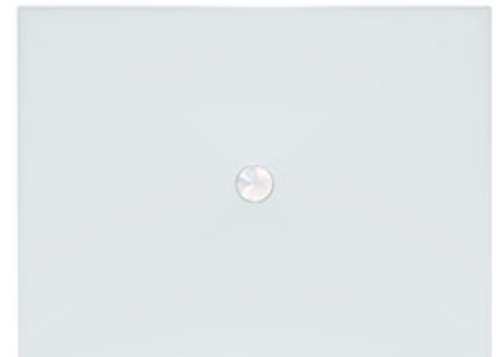
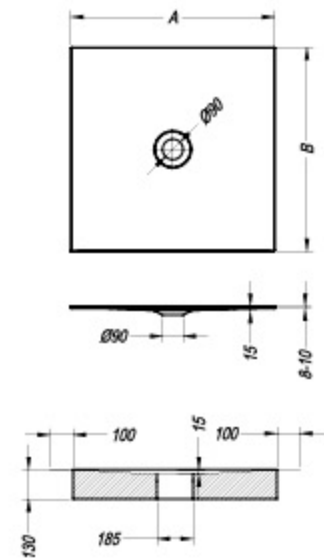

Installation at the floor level with a height compensation option up to 15 cm max.  
 Einbau auf Bodenniveau, Möglichkeit der Höhenanpassung bis max. 15 cm.  
 L'installation au fond avec la possibilité de compensation de l'hauteur jusqu'à 15 cm max.  
 Встройка на уровне пола, возможность компенсации высоты до макс. 15 см.

- 1 - shower tray / Duschwanne / douche baignoire / душевой поддон
- 2 - sanitary silicone / Sanitärsilikon / silicone sanitaire / санитарный силикон
- 3 - ceramics / Keramik / céramique / керамика
- 4 - waterproof film / wasserdichte Folie / film imperméable / водонепроницаемая пленка
- 5 - polystyrene / Styropor / polystyrène expansé / полистрол
- 6 - waterproof coating / wasserdichte Beschichtung / revêtement imperméable / водостойкое покрытие

The product is well suited for elderly users.  
 Das Produkt eignet sich für ältere Nutzer.  
 Le produit convient aux utilisateurs âgés.  
 Изделие подходит для людей пожилого возраста.



› 120-219 › 295

sanitary cast acrylic, Sanitär-Gussacryl,  
acrylique sanitaire coulé,  
литой Санитарный акрил

	A	VM
<b>Boston 100 x 100</b>	1000	155
<b>Boston 90 x 90</b>	900	155
<b>Boston 80 x 80</b>	800	155

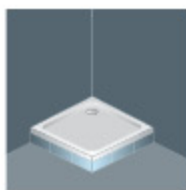

#### **Boston 100, 90, 80**

#### **Бостон 100, 90, 80**

- a shower tray for built-in installation, made from cast sanitary acrylic
- Duschwanne aus Guss-Sanitäracryl für den Einbau
- base de douche à installer, en acrylique sanitaire coulé
- душевой поддон для установки в/на пол из литого сантехнического акрила



#### **Boston 100/O, 90/O, 80/O**

#### **Бостон 100/O, 90/O, 80/O**

- a shower tray with panel, made from cast sanitary acrylic
- Duschwanne aus Guss-Sanitäracryl mit Schürze
- base de douche avec revêtement, en acrylique sanitaire coulé
- душевой поддон из литого сантехнического акрила с панелью

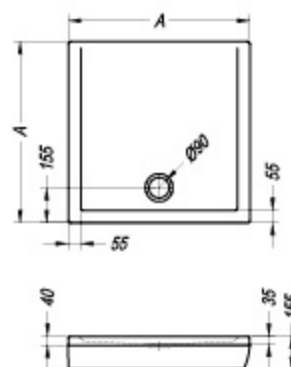

› 120-219 › 295

sanitary cast acrylic, Sanitär-Gussacryl,  
acrylique sanitaire coulé,  
литой Санитарный акрил

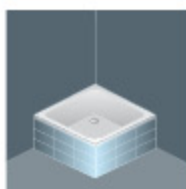

#### **Funky 120, 100 / Функи 120, 100**

- a shower tray with a seat for built-in installation, depth of 23cm, made from cast sanitary acrylic
- Duschwanne aus Guss-Sanitäracryl mit Einbausitz, Tiefe 23 cm
- base de douche avec siège à installer, 23 cm de profondeur, an acrylique sanitaire coulé
- душевой поддон из литого сантехнического акрила с интегрированным сиденьем, глубиной 23 см



#### **Funky 120/O, 100/O / Функи 120/O, 100/O**

- a shower tray with seat and panel, depth of 23cm, made from cast sanitary acrylic
- Duschwanne aus Guss-Sanitäracryl mit Sitz und Schürze, Tiefe 23 cm
- base de douche avec siège et revêtement, 23 cm de profondeur, an acrylique sanitaire coulé
- душевой поддон из литого санитарного акрила с интегрированным сиденьем, с панелью, глубиной 23 см

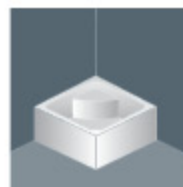

- seat
- Sitz
- siège
- сиденье

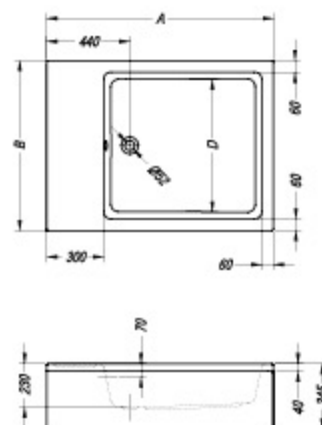

	A	B	VM
<b>Funky 120 x 90</b>	1200	900	345
<b>Funky 100 x 80</b>	1000	800	345

The product is well suited for elderly users.

Das Produkt ist geeignet für ältere Nutzer.

Le produit convient aux utilisateurs âgés.

Изделие подходит для людей пожилого возраста.



120-219 295

sanitary cast acrylic, Sanitär-Gussacryl,  
acrylique sanitaire coulé,  
литой Санитарный акрил

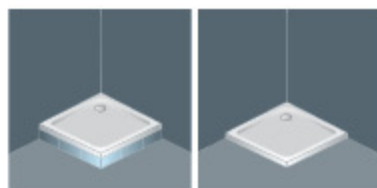

#### Evelin tray Q 120 / Евелин траы Q 120

- a shower tray for built-in installation or fixing on the floor, made from cast sanitary acrylic
- Duschwanne aus Guss-Sanitäracryl für den Einbau oder zur Bodenaufstellung
- base de douche à installer ou fixer sur le plancher en acrylique sanitaire coulé
- душевой поддон для установки в/на пол из литого сантехнического акрила



#### Evelin tray Q 120/O / Евелин траы Q 120/O

- a shower tray with panel, made from cast sanitary acrylic
- Duschwanne aus Guss-Sanitäracryl mit Schürze
- base de douche avec revêtement, en acrylique sanitaire coulé
- душевой поддон из литого сантехнического акрила с панелью



120-219 295

sanitary cast acrylic, Sanitär-Gussacryl,  
acrylique sanitaire coulé,  
литой Санитарный акрил

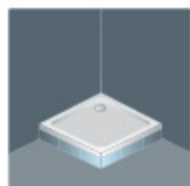

#### Evelin Tray Q 90, 80 / Евелин Траы Q 90, 80

- a shower tray for built-in installation, made from cast sanitary acrylic
- Duschwanne aus Guss-Sanitäracryl für den Einbau
- base de douche à installer, en acrylique sanitaire coulé
- душевой поддон для установки в/на пол из литого сантехнического акрила



#### Evelin Tray Q 90/O, 80/O / Евелин Траы Q 90/O, 80/O

- a shower tray with panel, made from cast sanitary acrylic
- Duschwanne aus Guss-Sanitäracryl mit Schürze
- base de douche avec revêtement, en acrylique sanitaire coulé
- душевой поддон из литого сантехнического акрила с панелью

	A	B	VM
Evelin tray Q 120 x 90	1200	900	165
Evelin tray Q 120 x 80	1200	800	165

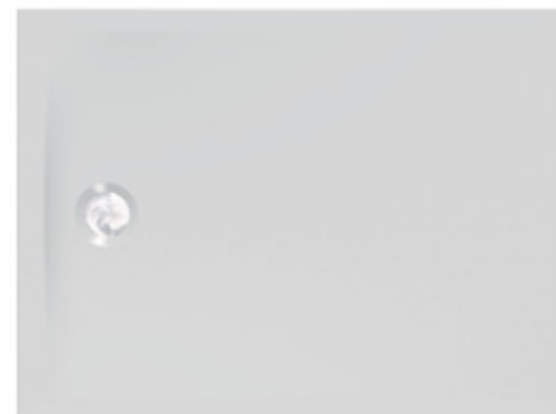
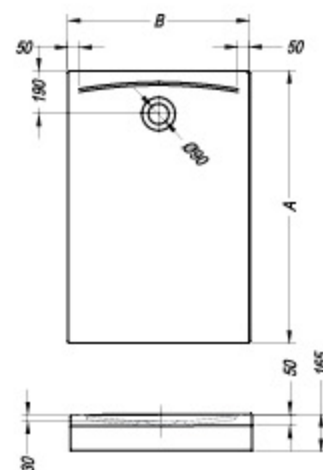

	A	B	VM
Evelin tray Q 90 x 90	900	900	157
Evelin tray Q 80 x 80	800	800	157

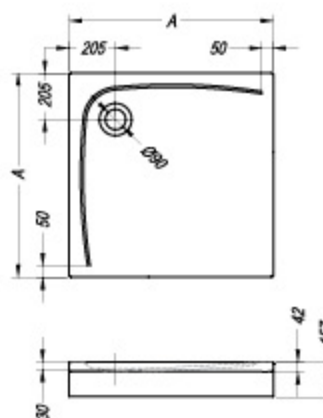



› 120-219 › 295

sanitary cast acrylic, Sanitär-Gussacryl,  
acrylique sanitaire coulé,  
литой Санитарный акрил

	A	VM
Trin 90 x 90	900	170
Trin 80 x 80	800	170

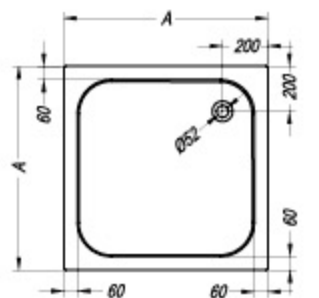

#### Trin 90, 80 / Трин 90, 80

- a shower tray for built-in installation, made from cast sanitary acrylic
- Duschwanne aus Guss-Sanitäracryl für den Einbau
- base de douche à installer, en acrylique sanitaire coulé
- душевой поддон для установки в/на пол из литого сантехнического акрила

#### Trin 90/O, 80/O / Трин 90/O, 80/O

- a shower tray with panel, made from cast sanitary acrylic
- Duschwanne aus Guss-Sanitäracryl mit Schürze
- base de douche avec revêtement, en acrylique sanitaire coulé
- душевой поддон из литого сантехнического акрила с панелью

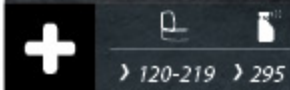

› 120-219 › 295

sanitary cast acrylic, Sanitär-Gussacryl,  
acrylique sanitaire coulé,  
литой Санитарный акрил

	A	B	C	D	VM
Malur 120 x 90	1200	900	650	350	155
Malur 100 x 80	1000	800	450	250	155

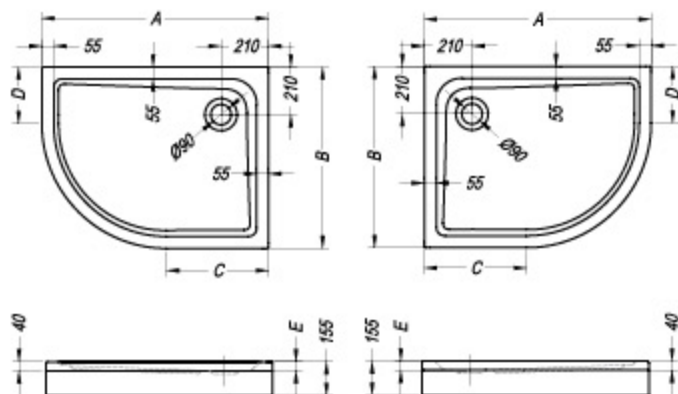

#### Malur 120x90, 100x80 / Малур 120x90, 100x80

- A shower tray for built-in installation, semi-circular, asymmetrical, made from cast sanitary acrylic
- Duschwanne aus Guss-Sanitäracryl für den Einbau, halbrund, asymmetrisch
- base de douche à installer, semi-circulaire, asymétrique, en acrylique sanitaire coulé
- полукруглый асимметричный душевой поддон из литого сантехнического акрила для установки в/на пол

#### Malur 120x90/O, 100x80/O / Малур 120x90/O, 100x80/O

- a shower tray with panel, semi-circular, asymmetrical, made from cast sanitary acrylic
- Duschwanne aus Guss-Sanitäracryl mit Schürze, halbrund, asymmetrisch
- base de douche avec revêtement, semi-circulaire, en acrylique sanitaire coulé
- полукруглый асимметричный душевой поддон из литого сантехнического акрила с панелью



Malur 120, 100 - L

Malur 120, 100 - R



120-219 295

sanitary cast acrylic, Sanitär-Gussacryl,  
acrylique sanitaire coulé,  
литой Санитарный акрил

	A	VM
Eisa 90 x 90	900	155

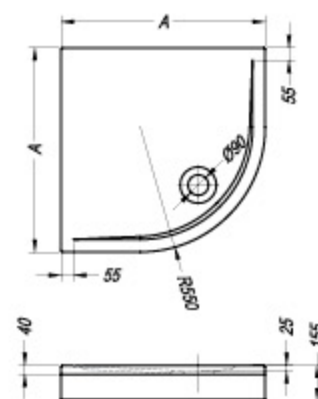

#### Elsa 90 / Еиса 90

- a shower tray for built-in installation, semi-circular, made from cast sanitary acrylic
- Duschwanne aus Guss-Sanitäracryl für den Einbau, halbrund
- base de douche à installer, semi-circulaire, en acrylique sanitaire coulé
- полукруглый душевой поддон из литого сантехнического акрила для установки в/на пол



#### Elsa 90/O / Еиса 90/O

- a shower tray with panel, semi-circular, made from cast sanitary acrylic
- Duschwanne aus Guss-Sanitäracryl mit Schürze, halbrund
- base de douche avec revêtement, semi-circulaire, en acrylique sanitaire coulé
- полукруглый душевой поддон из литого сантехнического акрила с панелью



120-219 295

sanitary cast acrylic, Sanitär-Gussacryl,  
acrylique sanitaire coulé,  
литой Санитарный акрил

	A	VM
Blues 100 x 100	1000	210
Blues 90 x 90	900	210

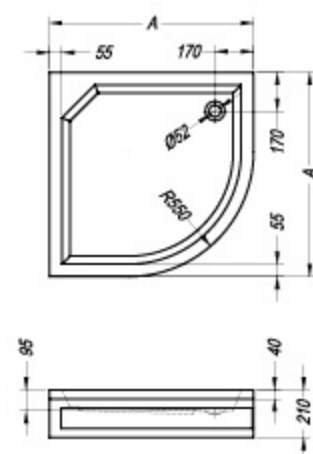

#### Blues 100, 90 / Блус 100, 90

- a shower tray for built-in installation, semi-circular, made from cast sanitary acrylic
- Duschwanne aus Guss-Sanitäracryl für den Einbau, halbrund
- base de douche à installer, semi-circulaire, en acrylique sanitaire coulé
- полукруглый душевой поддон из литого сантехнического акрила для установки в/на пол



#### Blues 100/O, 90/O / Блус 100/O, 90/O

- a shower tray with panel, semi-circular, made from cast sanitary acrylic
- Duschwanne aus Guss-Sanitäracryl mit Schürze, halbrund
- base de douche avec revêtement, semi-circulaire, en acrylique sanitaire coulé
- полукруглый душевой поддон из литого сантехнического акрила с панелью

#### Blues 90/30 / Блус 90/30

- a shower tray with three-sided panel, semi-circular, made from cast sanitary acrylic
- Duschwanne aus Guss-Sanitäracryl mit dreiseitiger Schürze, halbrund
- base de douche avec revêtement triangulaire, en acrylique sanitaire coulé
- полукруглый душевой поддон с трёхсторонней панелью из литого санитарного акрила







sanitary cast acrylic, Sanitär-Gussacryl,  
acrylique sanitaire coulé,  
литой Санитарный акрил

120-219 295

	A	VM
<b>Pony 90 x 90</b>	900	155
<b>Pony 80 x 80</b>	800	155

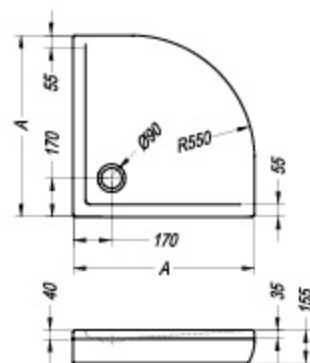

#### Pony 90, 80 / Пони 90, 80

- a shower tray for built-in installation, semi-circular, made from cast sanitary acrylic
- Duschwanne aus Guss-Sanitäracryl für den Einbau, halbrund
- base de douche à installer, semi-circulaire, en acrylique sanitaire coulé
- полукруглый душевой поддон из литого сантехнического акрила для установки в/на пол

#### Pony 90/O, 80/O / Пони 90/O, 80/O

- a shower tray with panel, semi-circular, made from cast sanitary acrylic
- Duschwanne aus Guss-Sanitäracryl mit Schürze, halbrund
- base de douche avec revêtement, semi-circulaire, en acrylique sanitaire coulé
- полукруглый душевой поддон из литого сантехнического акрила с панелью



sanitary cast acrylic, Sanitär-Gussacryl,  
acrylique sanitaire coulé,  
литой Санитарный акрил

120-219 295

	A	VM
<b>Dixie 90 x 90</b>	900	410

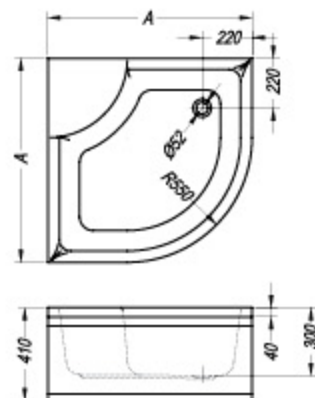

#### Dixie 90 / Дикси 90

- a shower tray for built-in installation, semi-circular, depth of 30cm, made from cast sanitary acrylic
- Duschwanne aus Guss-Sanitäracryl für den Einbau, Tiefe 30 cm, halbrund
- base de douche à installer, semi-circulaire, 30 cm de profondeur, en acrylique sanitaire coulé
- полукруглый душевой поддон из литого сантехнического акрила, глубиной 30см для установки в/на пол

#### Dixie 90/O / Дикси 90/O

- a shower tray with panel, semi-circular, depth of 30cm, made from cast sanitary acrylic
- Duschwanne aus Guss-Sanitäracryl mit Schürze, Tiefe 30 cm, halbrund
- base de douche avec revêtement, semi-circulaire, 30 cm de profondeur, en acrylique sanitaire coulé
- полукруглый душевой поддон из литого сантехнического акрила, глубиной 30см с панелью



- seat
- Sitz
- siège
- сиденье



The product is well suited for elderly users.  
Das Produkt ist geeignet für ältere Nutzer.  
Le produit convient aux utilisateurs âgés.  
Изделие подходит для людей пожилого возраста.



120-219 295

sanitary cast acrylic, Sanitär-Gussacryl,  
acrylique sanitaire coulé,  
литой Санитарный акрил



#### Bebop 90 / Бебоп 90

- a shower tray for built-in installation with seat,  
semi-circular, made from cast sanitary acrylic  
- Duschwanne aus Guss-Sanitäracryl für den  
Einbau mit Sitz, halbrund  
- base de douche avec siège à installer,  
semi-circulaire, en acrylique sanitaire coulé  
- полукруглый душевой поддон из литого  
сантехнического акрила, с сиденьем для  
установки в/на пол



- seat  
- Sitz  
- siège  
- сиденье



#### Bebop 90/O / Бебоп 90/O

- a shower tray with panel and seat,  
semi-circular, made from cast sanitary acrylic  
- Duschwanne aus Guss-Sanitäracryl  
mit Schürze und Sitz, halbrund  
- base de douche avec revêtement avec siège,  
semi-circulaire, en acrylique sanitaire coulé  
- полукруглый душевой поддон из литого  
сантехнического акрила, с сиденьем, с панелью

The product is well suited for elderly users.  
Das Produkt ist geeignet für ältere Nutzer.  
Le produit convient aux utilisateurs âgés.  
Изделие подходит для людей  
пожилого возраста.

	A	VM
Bebop 90 x 90	900	215

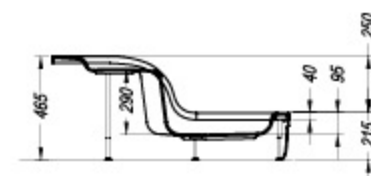
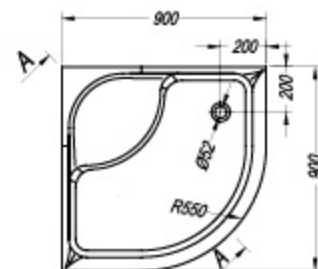

	A	VM
Evelin tray R 90 x 90	900	157
Evelin tray R 80 x 80	800	157



120-219 295

sanitary cast acrylic, Sanitär-Gussacryl,  
acrylique sanitaire coulé,  
литой Санитарный акрил



#### Evelin tray R 90 x 90, 80 x 80 / Евелин трай Р 90 x 90, 80 x 80

- a shower tray for built-in installation, semi-circular, made from cast sanitary acrylic  
- Duschwanne aus Guss-Sanitäracryl für den Einbau, halbrund  
- base de douche à installer, semi-circulaire, en acrylique sanitaire coulé  
- полукруглый душевой поддон из литого сантехнического акрила  
для установки в/на пол



#### Evelin tray R 90 x 90/O, 80 x 80/O / Евелин трай Р 90 x 90/O, 80 x 80/O

- a shower tray with panel, semi-circular, made from cast sanitary acrylic  
- Duschwanne aus Guss-Sanitäracryl mit Schürze, halbrund  
- base de douche avec revêtement, semi-circulaire, en acrylique sanitaire coulé  
- полукруглый душевой поддон из литого сантехнического акрила с панелью

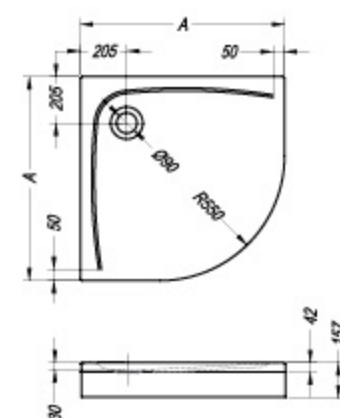



sanitary cast acrylic, Sanitär-Gussacryl,  
acrylique sanitaire coulé,  
литой Санитарный акрил

	A	VM
Ontex 90 x 90	900	170
Ontex 80 x 80	800	170

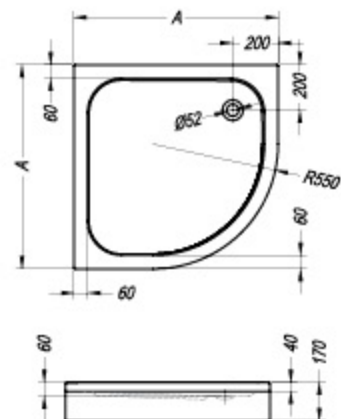

#### Ontex 90, 80 / Онтекс 90, 80

- a shower tray for built-in installation, semi-circular, made from cast sanitary acrylic
- Duschwanne aus Guss-Sanitäracryl für den Einbau, halbrund
- base de douche à installer, semi-circulaire, en acrylique sanitaire coulé
- полукруглый душевой поддон из литого сантехнического акрила для установки в/на пол



#### Ontex 90/O, 80/O / Онтекс 90/O, 80/O

- a shower tray with panel, semi-circular, made from cast sanitary acrylic
- Duschwanne aus Guss-Sanitäracryl mit Schürze, halbrund
- base de douche avec revêtement, semi-circulaire, en acrylique sanitaire coulé
- полукруглый душевой поддон из литого сантехнического акрила с панелью

