





WHY CHOOSE A KOLPA SAN BATHTUB?

WARUM EINE KOLPA SAN BADEWANNE?

POURQUOI CHOISIR LA BAIGNOIRE KOLPA SAN?

ПОЧЕМУ СЛЕДУЕТ ОСТАНОВИТЬСЯ НА ВЫБОРЕ ВАННЫ KOLPA SAN?



- A choice of **5** massage systems
- A choice of different quality materials (Kerrock and acrylic)
- Ergonomic form with pure geometric lines
- More than bathtub **50** accessories available (massage systems, faucets, seats and headrests)
- A selection of different screens and enclosures
- Various options for installation (standalone, built-in with tub surround wall or panel)
- More than **80** models of bath tubs for a variety of bathroom layouts

- Choix entre **5** systèmes de massage
- Choix entre les matériaux de qualité différente (Kerrock et acrylique)
- Design ergonomique avec des formes géométriques pures
- Option d'installation supplémentaire de plus de **50** éléments supérieur sur la baignoire (systèmes de massage, armatures, sièges et repose-tête)
- Option d'installation supplémentaire des parois et cabines de douche
- diverses options de positionnement et installation (autoportant, encastré avec le bord maçonné ou avec le revêtement)
- plus de **80** modèles de baignoires pour équiper tous types de salles de bains

- Auswahl von **5** Arten von Massagesystemen
- Auswahl zwischen verschiedenen Qualitäten von Materialien (Kerrock und Acryl)
- ergonomisches Design mit reinen geometrischen Formen
- Möglichkeit eines Überbaus der Wanne mit mehr als **50** Überstandelementen (Massagesysteme, Armaturen, Sitze und Kopfstützen)
- Möglichkeit eines Überbaus mit Duschtrennwänden und Kabinen
- Möglichkeiten des Auf- und Einbaus (selbstsehende, Montage mit gemauertem Rand oder Mit Belägen)
- mehr als **80** Modelle von Badewannen für die Ausstattung von verschiedenen Arten von Badezimmern

- возможность выбора между **5** массажными системами
- возможность выбора между различными качественными материалами (керрок и акрил)
- эргономический дизайн с чистыми геометрическими формами
- возможность модернизации ванны с более чем **50** выше-стандартными элементами (массажные системы, сантехническая арматура, сиденья, подголовники)
- возможность модернизации с душами параванами и кабинами
- различные варианты компоновки и установки (отдельные, встраиваемые)
- более **80** моделей ванн для оборудования всех видов ванных комнат



Massage system
Massagesystem
Système de l'hydro massage
Массажная система

› 020



Accessories
Zubehör
Accessoires
Аксессуары для
ванной комнаты

› 282



Protective paint
Schutzanstrich
Revêtement de protection
Защитное покрытие

› 295



Accessories For bathtubs
Zubehör für Badewannen
Accessoires pour baignoires
Аксессуары для ванн

› 291

* cast sanitary acrylic, gegossenes Sanitäracryl, acrylique moulé sanitaire, литой санитарный акрил
kerrock, Kerrock, le kerrock, керрок

** massage systems, massagesysteme,
système de l'hydro massage, массажная система



MASSAGE AND BATHTUBS

MASSAGE- UND BADEWANNEN
BAIGNOIRES DE MASSAGE ET DE BAIN
МАССАЖНЫЕ ВАННЫ И ВАННЫ



Bathtubs - shapes and sizes

Badewannen - Formen und Maße

Baignoires - formes et dimensions

Ванны – таблица форм и размеров

a x b	68	70	75	78	80	85	88	90
203								
200								Rapido 054
196								
195								
190								Elektra 060 Bell 058 Bell E2 058 Bell 40 059
185								
183								Comodo-FS 031
180				Dream 039	Aida 064 Armida 063 Carmen 065 Copella-FS P026 Copella-LIGHT P028 Elektra 060 Eroica FS 034 Destiny 066 Bell 058 Bell E2 058 Bell 40 059	Antiq-FS P029 Gloria-FS P022 Ramona-FS P014 Soave-FS P030 Adonis*** 035	Pandora 062	Marilyn-FS 033 Bell 058 Bell E2 058 Bell 40 059
178								Siris-FS*** 036
174		Alys-DIUS-FS P032	Milo-FS P010				Alys-FS P033	
173				Pandora FS 037				
170		Elektra 060 Tamia 070 Destiny 066	Aida 064 Carmen 065 Destiny 066 Elektra 060 Figaro 072 Tamia 070		Carol** 068 Elektra 060 Bell 058 Bell E2 058 Bell 40 059	Dalia-FS*** 038		
165								
163	Pandora FS 080							
160		Adela 073 Destiny 066 Tamia 070	Aida 064 Elektra 060		Figaro 072			Calando 053
150		Adela 073 Evelin 069 Figaro 072 Tamia 070					Calando 053	
145								
140		Accordo 074 Evelin 069 Tamia 070 Tamia/S*** 071						
130		Ester 075						
120		Cavatina 076	Boogie 077					
100		Mini* 077						



dimensions in cm:
Abmessungen in cm:
dimensions en cm:
размеры в см:

shape / Form / forme / форма:
classical, klassisch, classique, классическая
corner, Eckbadewanne, angulaire, угловая
oval, oval, ovale, овальная
round, rund, ronde, круглая
asymmetrical, asymmetrisch, asymétrique, асимметричная
along the wall, an der Wand entlang, le long du mur, вдоль стены

material / Material / matériau / материал:

acrylic, Acryl, l'acrylique, акрил
kerrock, Kerrock, le kerrock, керрок



Select the size of your bathtub and check next page to see where in the catalogue you can find it.

Suchen Sie die richtigen Abmessungen für Ihre Badewanne aus. Dann schauen Sie auf der nächsten Seite, wo im Katalog Sie sie finden können.

Sélectionnez la baignoire dont les dimensions vous conviennent et vérifiez, sur la page suivante, où la trouver dans le catalogue.

Выберите себе ванну желаемого размера. На следующей странице каталога указана страница, где ее можно посмотреть.

› 16-18

a x b	95	100	110	117	120	125	130	140	150	160	180
203		Lolly P018									
200		Atys P033									
196				Tristan* P025							
195						Adam&Eva 055					
190	Norma 057				Adam&Eva FS 030 Nabucco 056						
185											
183											
180		Capella-LUX FS P027								Samson 061	Opera 040
178											
174											
173											
170			Beatrice 052 Lulu** 051		Chad** 050						
165											
163											
160										Swan** 042 Gaia 041	
150									Alba** 045 Largo 044 Loco** 046 Orfeo 043		
145											
140								Evelin 047 Divante** 048 Orfeo 043			
130							Royal** 049				
120											
100											

* bathtub without cladding
* Badewanne ohne Schürze
* baignoire sans revêtement
* ванна без обшивки

** bathtub with an installed seat
** Badewanne mit integriertem Sitz
** baignoire avec siège intégré
** ванна со встроенным сиденьем

*** bathtub and cladding in one unit
*** Badewanne und Verkleidung in einem Stück
*** baignoire et revêtement en une pièce
*** ванна с обшивкой

*Premium***Massage and bathtubs**

Massage- und Badewannen

Baignoires de massage et de bain

Массажные ванны и ванны

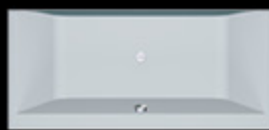
**BOUL bathtub-FS 165x85** 006*Premium***MILO bathtub-FS 174x75** 010*Premium***RAMONA bathtub-FS 180x80** 014*Premium***LOLLY bathtub-FS 203x100** 018*Premium***GLORIA-FS 180x80** 022*Premium***TRISTAN-FS 196x117** 025*Premium***COPELIA-FS 180x80** 026*Premium***COPELIA LUX-FS 180x100** 027*Premium***COPELIA LIGHT-FS 180x80** 028*Premium***ANTIQ-FS 183x80** 029*Premium***SOAVE-FS 180x80** 030*Premium***ATYS DUO-FS 174x70** 032*Premium***ATYS-FS 180x85** 033*Premium***ATYS 200x100** 033*Premium***Massage and bathtubs**

Massage- und Badewannen

Baignoires de massage et de bain

Массажные ванны и ванны

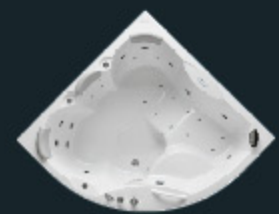
**ADAM & EVA-FS 190x120** 030**COMODO-FS 185x90** 031**BLANCHE-FS 180x85** 032**MARILYN-FS 180x90** 033**EROICA-FS 180x80** 034**ADONIS-FS 180x80** 035**SIRIS-FS 178x88** 036**PANDORA bathtub-FS**
173x78, 163x68 037**DALIA-FS 170x80** 038**DREAM-SP 180x80** 039**OPERA Ø 180** 040**GAIA 160x160** 041



SWAN 160x160 042



ORFEO 150x150, 140x140 043



LARGO 150x150 044



ALBA 150x150 045



LOCO 150x150 046

EVELIN bathtub
140x140, 120x120 047

DIVANTE 140x140 048



ROYAL 130x130, 120x120 049



CHAD-L 170x120 050



CHAD-R 170x120 050



LULU-L 170x110 051



LULU-R 170x110 051



BEATRICE-L 170x110(70) 052



BEATRICE-R 170x110(70) 052



CALANDO-L 160x90, 150x85 053



CALANDO-R 160x90, 150x85 053

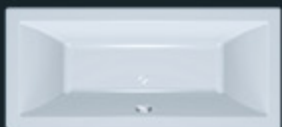

RAPIDO 200x90 054



ADAM & EVA 195x125 055



NABUCCO 190x120 056

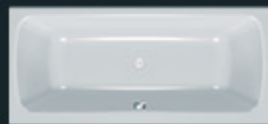
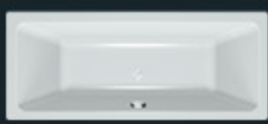

NORMA 190x95 057

BELL 190x90, 180x90, 180x80, 170x80
BELL 40 190x90, 180x90, 180x80, 170x80 058
BELL E2 190x90, 180x90, 180x80, 170x80 059ELEKTRA 190x90, 180x80, 170x80,
170x75, 170x70, 160x75 060SAMSON 180x160, 061
SAMSON 20 180x160
SAMSON 40 180x160PANDORA bathtub 062
180x85, 170x75

ARMIDA 180x80 063



AIDA 180x80, 170x75, 160x75 064



CARMEN 180x80 065

DESTINY 180x80, 170x75,
170x70, 160x70 066



VALIS 170x80 067



CAROL 170x80/S 068



EVELIN bathtub 170x75, 170x70, 160x70, 150x70, 140x70 069



TAMIA 170x75, 170x70, 160x70, 150x70, 140x70 070



TAMIA 140x70/S 071

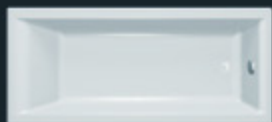

FIGARO 170x75, 160x80, 150x70 072



ADELA 160x70, 150x70 073



ACCORDO 140x70 074



ESTER 130x70 075



CAVATINA 120x70/S 076



BOOGIE 120x75 077



MINI 100x70 077







Option of installation and upgrade of bathtubs

Möglichkeiten der Montage und des Ausbaus von Badewannen

Options d'installation et d'installation des éléments supplémentaires pour les baignoires

Возможности установки и модернизации ванн



Massage bathtubs

Massagebadewannen

Baignoires de massage

Массажные системы в ваннах



Water massage system

Wassermassagesystem

Système de l'hydro massage

Система гидромассажа

> 50



Air massage system

Luftmassagesystem

Système de massage air

Система аэромассажа

> 52



Water and air massage system

Wasser- und Luftmassagesystem

Système de massage combiné air – eau

Системы аэро - и гидромассажа

> 51



Vital massage system

Vital Massage Systeme

Vital de massage Luxus

Массажная система Vital

> 53



Luxus + massage system

Luxus + Massage Systeme

Système de massage Luxus +

Люкс + массажная система

> 54



Super water jet

Super Wasserdüse

La buse eau super

Супер водяная форсунка

Ø cca 75 mm, angle 30° in all directions

Ø cca 75 mm, Winkel 30° in alle Richtungen

Ø cca 75 mm, angle 30° dans toutes les directions

Ø cca 75 мм, угол 30° во всех направлениях



Water jet

Wasserdüse

Jets hydrauliques

Водяная форсунка

Ø cca 63 mm, angle 15° in all directions

Ø cca 63 mm, Winkel 15° in alle Richtungen

Ø cca 63 mm, angle 15° dans toutes les directions

Ø cca 63 мм, угол 15° во всех направлениях



Micro water jet

Wassermikrodüsen

La micro-buse eau

Микро водяная форсунка

Ø cca 25 mm

Ø ca. 25 mm

Ø cca 25 mm

Диаметр около 25мм



Air jet

Luftwasserdüse

La buse air

Воздушная форсунка

Ø cca 25 mm

Ø ca. 25 mm

Ø cca 25 mm

Диаметр около 25мм



6 micro water jets (for back massage)

6 Mikro-Wasserdüsen (Rückenmassage)

6 micro-buses eau (pour le massage du dos)

6 водяных микро форсунок (для массажа спины)

Ø cca 25 mm

Ø ca. 25 mm

Ø cca 25 mm

Диаметр около 25мм



2 micro water jets (for foot massage)

2 Mikro-Wasserdüsen (für Fußmassage)

2 micro-buses eau (Pour le massage des pieds)

2 водяные микро форсунки (для массажа ступней)

Ø cca 25 mm

Ø ca. 25 mm

Ø cca 25 mm

Диаметр около 25мм

Installation

Montage
Installation
Установка

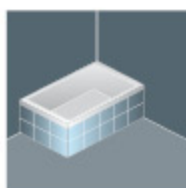

Bathtub, built-in

Badewanne, zum Einbau
Baignoire à encastrer
Встраиваемая ванна



Bathtub with panel

Badewanne mit Schürze
Baignoire avec tablier de façade
Ванна с панелью



Bathtub with fixed panel

Badewanne mit geklebter Beschichtung
Baignoire avec le revêtement adhésif
Ванна с ламинированным покрытием

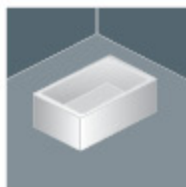

Freestanding bathtub with panel

Freistehende Badewanne mit Beschichtung
Baignoire autoportante avec le revêtement
Отдельная ванна с покрытием

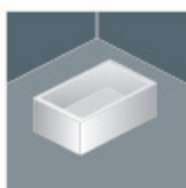

Freestanding bath tub with fixed panel

Freistehende Badewanne
mit geklebter Beschichtung
Baignoire autoportante
avec le revêtement adhésif
Отдельная ванна
с ламинированным покрытием



Upgrade

Ausbau
Améliorer
Модернизация



Massage system

Massagesystem
Système de l'hydro massage
Массажная система

> 20



Twin-panel doors – shower screens

Flügeltrennwände - Duschtrennwände
Cloisons latérales - pare-douches
Душ параван

> 120



Accessories

Zubehör
Accessoires
Аксессуары для ванн

> 282



Headrests

Kopfstützen
Repose tête
Подголовники

> 290



Bathroom seats

Sitze und Hocker fürs Bad
Sièges de bain
Сиденья для ванных комнат

> 291



Massage bathtubs

Massagebadewannen

Baignoires de massage

Массажные системы в ваннах

Water massage system I. <small>PNEUMATIC</small>	Water and air massage system <small>ELECTRIC</small>	Air massage system <small>ELECTRIC</small>	Vital massage system <small>ELECTRIC</small>	Luxus + massage system <small>ELECTRIC</small>	Micro water jets for massage systems <small>OPTIONAL (Massage for the body)</small>
Wassermassage System I. <small>PNEUMATISCH</small>	Wasser- und Luftmassage system <small>ELECTRISCH</small>	Luftmassagesystem <small>ELECTRISCH</small>	Vital Massagesystem <small>ELECTRISCH</small>	Luxus + Massagesystem <small>ELECTRISCH</small>	Mikro-Wasserdüsen für Massagesysteme <small>OPTIONAL (Massage für den Körper)</small>
Système d'hydro massage I. <small>PNEUMATIQUE</small>	Système de massage combiné air-eau <small>ELECTRIQUE</small>	Système de massage à air <small>ELECTRIQUE</small>	Système de massage Vital <small>ELECTRIQUE</small>	Système de massage Luxus + <small>ELECTRIQUE</small>	Les micro-buses eau pour les systèmes de massage <small>OPTIONAL (Massage pour le corps)</small>
Система гидромассажа I. <small>ПНЕУМАТИЧЕСКАЯ</small>	Система аэро- и гидромассажа <small>ЭЛЕКТРИЧЕСКАЯ</small>	Система аэромассажа <small>ЭЛЕКТРИЧЕСКАЯ</small>	Система массажа Витал <small>ЭЛЕКТРИЧЕСКАЯ</small>	Система массажа люкс + <small>ЭЛЕКТРИЧЕСКАЯ</small>	Водяные микро форсунки для массажных систем <small>ОПЦИОНАЛЬНО (массаж для тела)</small>

Copella-FS 180, Copella Lux-FS 180, Copella Light-FS 180				•		
Adam&Eva-FS 190				•		
Comodo-FS 185				•		
Marilyn-FS 180				•		
Eroica-FS 180				•		
Adonis-FS 180				•		
Siris-FS 178				•		
Dream-SP 180				•		
Opera 180					•	
Opera 180/O					•	
Gala 160						•
Gala 160/O						•
Swan 160		•				•
Swan 160/O		•			•	•
Orfeo 150, Orfeo 140	•	•				
Orfeo 150/O, Orfeo 140/O	•	•				
Largo 150	•	•				•
Largo 150/O	•	•			•	•
Alba 150	•	•				•
Alba 150/O	•	•			•	•
Loco 150	•	•				•
Loco 150/O	•	•			•	•
Evelin bathtub 140, Evelin bathtub 120	•					
Evelin bathtub 140/O, Evelin bathtub 140/O	•					
Divante 140	•					
Divante 140/O	•					
Royal 130	•	•				
Royal 130/O	•	•				
Chad 170	•	•				•
Chad 170/O	•	•			•	•



Massage bathtubs

Massagebadewannen

Baignoires de massage

Массажные системы в ваннах

	Water massage system I. <small>PREMIERE</small>	Water and air massage system <small>ELECTRIC</small>	Air massage system <small>ELECTRIC</small>	Vital massage system <small>ELECTRIC</small>	Luxus + massage system <small>ELECTRIC</small>	Micro water jets for massage systems <small>OPTIONAL (Massage for the body)</small>
	Wasser-massage System I. <small>PREMIERE</small>	Wasser- und Luftmassage-system <small>ELECTRISCH</small>	Luftmassage-system <small>ELECTRISCH</small>	Vital Massage-system <small>ELECTRISCH</small>	Luxus + Massage-system <small>ELECTRISCH</small>	Mikro-Wasser-dösen für Massage-systeme <small>OPTIONAL (Massage für den Körper)</small>
	Système d'hydro-massage I. <small>PREMIERE</small>	Système de massage combiné air-eau <small>ELECTRIQUE</small>	Système de massage à air <small>ELECTRIQUE</small>	Système de massage Vital <small>ELECTRIQUE</small>	Système de massage Luxus + <small>ELECTRIQUE</small>	Les micro-buses eau pour les systèmes de massage <small>OPTIONAL (Massage pour le corps)</small>
	Система гидромассажа I. <small>ПРЕМИЕРНАЯ</small>	Система аэро- и гидромассажа <small>ЭЛЕКТРИКАЯ</small>	Система аэромассажа <small>ЭЛЕКТРИКАЯ</small>	Система массажа Витал <small>ЭЛЕКТРИКАЯ</small>	Система массажа люкс + <small>ЭЛЕКТРИКАЯ</small>	Водяные микро форсунки для массажных систем <small>Опция (масса для тела)</small>
Lulu 170			•	•		•
Lulu 170/O			•	•	•	•
Beatrice 170			•	•		•
Beatrice 170/O			•	•	•	•
Calando 160, Calando 150			•	•		•
Calando 160/O, Calando 150/O			•	•	•	•
Rapido 200			•	•	•	•
Rapido 200/O			•	•	•	•
Adam&Eva 195			•	•	•	•
Adam&Eva 195/O			•	•	•	•
Nabucco 190			•	•	•	•
Nabucco 190/O			•	•	•	•
Norma 190			•	•	•	•
Norma 190/O			•	•	•	•
Bell 190, Bell 180, Bell 170			•	•		•
Bell 190/O, Bell 180/O, Bell 170			•	•	•	•
Elektra 190, Elektra 180, Elektra 170x75, Elektra 160			•	•		•
Elektra 190/O, Elektra 180/O, Elektra 170x75/O, Elektra 160/O			•	•	•	•
Samson 180				•		•
Samson 180/20, Samson 180/40				•	•	•
Pandora bathtub 180, Pandora bathtub 170						
Pandora bathtub 180/O, Pandora bathtub 170/O						
Armida 180		•		•		•
Armida 180/O		•		•	•	•
Aida 180, Aida 170		•		•		•
Aida 180/O, Aida 170/O		•		•	•	•
Carmen 180, Carmen 170		•		•		•
Carmen 180/O, Carmen 170/O		•		•	•	•
Destiny 180, Destiny 170, Destiny 160		•		•		•
Destiny 180/O, Destiny 170/O, Destiny 160/O		•		•	•	•
Valis 170		•		•		•
Valis 170/O		•		•	•	•
Evelin bathtub 170x75		•		•		•
Evelin bathtub 170x75/O		•		•	•	•
Tamia 170x75		•		•		•
Tamia 170x75/O		•		•	•	•



Water massage system (pneumatic)

Wassermassagesystem (pneumatisch)
Système de l'hydro massage (pneumatique)
Система гидромассажа (пневматическая)

This hydro massage system is based on pressure created by water pump directing water flow through massage jets as mixture of water and air. As a result, your body is being intensively massaged by thousands of extremely rapidly moving air bubbles. A regulation system allows controlling air and water flow through the massage jets.

Das Hydromassagesystem basiert auf durch die Wasserpumpe erzeugtem Druck, welcher den Strahl aus Wasser und Luft durch die Massagedüsen leitet. Durch Tausende von schnellbewegenden Luftbläschen wird der ganze Körper intensiv massiert. Durch eine Luftflusssteuerung wird die Stärke des Massagestrahls geregelt.

Ce système d'hydro massage fonctionne par le biais d'une pompe hydraulique, créant la pression ensuite propulsée vers les buses de massage tout en mélangeant l'eau et l'air. Grâce à ce courant, le corps entier est massé intensivement par des milliers de bulles d'air propulsés à une grande vitesse. Ce flux d'air est contrôlé par un système de réglage.

Система гидромассажа работает таким образом: водяной насос создает давление и приток воды через массажные сопла, которые направляют струю воды смешанную с воздухом. Тысяча воздушных шариков с большой скоростью воды интенсивно массируют человека. Приток воды контролируется отмеренным поступлением воздуха в массажные форсунки.

System functions:

- water pump
- water jets
- pneumatic switch
- air flow regulator min-max
- overflow set
- bathtub support frame
- high performance water pump, 6 microjets with switch
- 2 additional water microjets
- bathtub panel (for specific types)

Systemfunktionen:

- Wasserpumpe
- Wasserdüsen
- Pneumatikschalter
- Luftdurchflussregler Min - Max
- Überlaufgarntur
- Badewannenuntergestell
- Hochleistungswasserpumpe, 6 Mikrodüsen mit Schalter
- 2 zusätzliche Wassermikrodüsen
- Schürze (für bestimmte Modelle)

Fonctions du système:

- pompe hydraulique
- jets hydrauliques
- une commande pneumatique
- réglage d'injection d'air min - max
- bonde d'évacuation, trop-plein
- cadre de maintien
- pompe à haute puissance, 6 micro-jets à eau avec interrupteur
- 2 micro-jets d'eau additionnels
- tablier de façade (pour certains modèles)

Состав системы:

- водяной насос
- водяных форсунок
- пневматическое включение
- регулятор потока воздуха мин-макс.
- слив-перелив
- основание ванны
- 6 водяных микро-форсунок с переключателем и водяным насосом
- две дополнительные водяные микро-форсунок
- покрытие ванны (некоторые модели)



- OPTIONS FOR CERTAIN BATHTUB MODELS:
- OPTIONEN FÜR BESTIMMTE MODELLE VON BADEWANNEN:
- OPTIONS POUR CERTAINS MODÈLES DE BAIGNOIRES:
- ВАРИАНТЫ ДЛЯ ОПРЕДЕЛЕННЫХ ТИПОВ ВАНН:





Water and air massage system (electronic)

Wasser- und Luftmassagesystem (elektronisch)

Système de massage combiné air – eau (électronique)

Системы аэро - и гидромассажа (электронная)

This system combines both water and air massage systems. Their interacting effect does great work for human organism with pure relaxation and a complete regeneration as a result. The air massage system is based on the air pressure generated by an air pump. The strong flow of compressed air running through the air nozzles results in millions of tiny air bubbles mixing with water and moving at high speed. It is their kinetic energy which provides massage to your body.

In diesem System sind alle Elemente von Wasser- und Luftmassagesystem integriert. In einem Wechselspiel wirken beide Systeme intensiv auf den menschlichen Organismus wodurch er entspannt und regeneriert wird. Das Luftmassagesystem basiert auf durch die Luftpumpe erzeugtem Druck, welcher die komprimierte Luft durch Luftdüsen leitet. Diese Die entstandenen Luftbläschen, die sich mit dem Wasser vermischen und mit großer Geschwindigkeit bewegen, massieren mit ihrer kinetischen Energie den Körper.

Ce système intègre tous les éléments des systèmes de massage aquatique et pneumatique. Leur effet réciproque affecte intensivement l'organisme humain, il le relaxe et le régénère complètement. Le fonctionnement du système de hydro massage est basé sur la pression créée par une pompe à eau qui mène l'air comprimé dans le tuyau pneumatique. L'air est ainsi divisé en minuscules bulles d'air qui se mélangent à l'eau. C'est grâce à par leur énergie cinétique que le corps massé.

В систему включены все элементы водяной и воздушной массажной системы. Взаимодействие этих двух систем интенсивно действует на человеческий организм, его полностью регенерирует и расслабляет. Воздушная массажная система работает следующим образом: водяной насос создаёт поток сжатого воздуха, который проходит через воздушные форсунки. Форсунки разбивают воздух на мелкие воздушные пузырьки, смешивающиеся с водой, своей кинетической энергией массируют тело пользователя.

System functions:

- air pump
- water pump
- super water jets
- air jets
- electronic switch for water and air pumps
- electronic regulation of the air pump rpm
- water level sensor
- overflow set
- bathtub support frame
- high performance water pump, 6 water microjets with switch
- 2 additional water microjets
- bathtub panel (for specific types)

Systemfunktionen:

- Luftpumpe
- Wasserpumpe
- Hochleistungswasserdüsen
- Lüftdüsen
- elektronische Einschaltung für die Wasser- und Luftpumpe
- Elektroregelung für die Drehzahl der Luftpumpe
- Sensor für das Wassemiveau
- Abfluss - Durchflussgarnitur
- Untergestell
- Hochleistungswasserpumpe, 6 Mikrodüsen mit Schalter
- 2 zusätzliche Wassermikrodüsen
- Schürze (für bestimmte Modelle)

Fonctions du système:

- pompe à air
- pompe hydraulique
- super jets hydrauliques
- jets d'air
- interrupteur électronique pour les pompes à air et à eau
- réglage électronique de vitesse de rotation de la pompe à air
- senseur niveau d'eau
- bonde d'évacuation et un trop-plein
- cadre de maintien
- pompe à haute puissance, 6 micro-jets à eau avec interrupteur
- 2 micro-jets d'eau additionnels
- tablier de façade (pour certains modèles)

Состав системы:

- воздушный насос
- водяной насос
- супер водяные форсунки
- воздушных форсунок
- электронное включение водяного и воздушного насосов
- электронная регулировка количества оборотов водяного насоса
- датчик уровня воды
- слив-перелив
- основание ванны
- 6 водяных микро-форсунок с переключателем и водяным насосом
- 2 дополнительные водяные микро-форсунки
- покрытие ванны (некоторые модели)

- OPTIONS FOR CERTAIN BATHTUB MODELS:
- OPTIONEN FÜR BESTIMMTE MODELLE VON BADEWANNEN:
- OPTIONS POUR CERTAINS MODÈLES DE BAINOIRES:
- OPZIONI PER SPECIFICI MODELLI DI VASCHE DA BAGNO:
- ВАРИАНТЫ ДЛЯ ОПРЕДЕЛЕННЫХ ТИПОВ ВАНН:

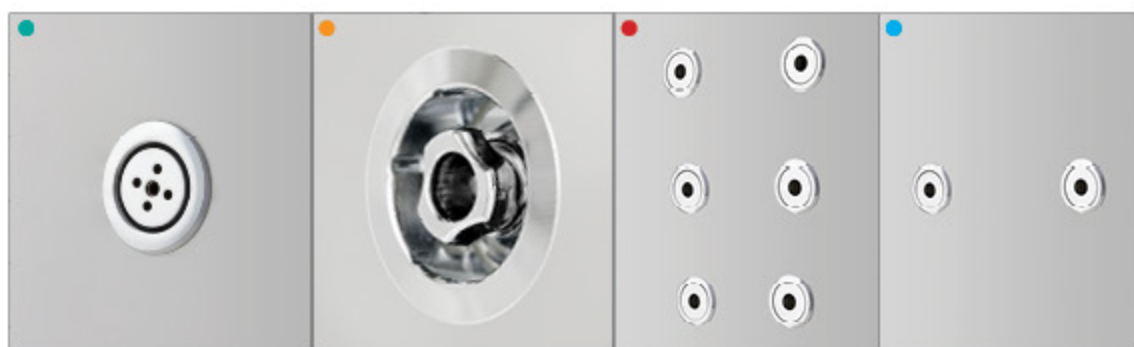



Air massage system (FS)

Luftmassagesystem (FS)

Système de massage air (FS)

Система аэромассажа (ФС)



System functions:

- air pump
- air jets
- electronic switch for air pump
- water level sensor
- overflow set
- bathtub support frame
- bathtub panel

Systemfunktionen:

- Luftpumpe
- Luftdüsen
- elektronische Einschaltung für die Luftpumpe
- Sensor für das Wasserniveau
- Abfluss - Durchflussgarmitur
- Untergestell
- Schürze

Fonctions du système:

- pompe à air
- jets d'air
- Interrupteur électronique pour la pompe à air
- senseur pour le niveau d'eau
- bonde d'évacuation et un trop-plein
- cadre de maintien de la baignoire
- tablier de façade

Состав системы:

- водяной насос
- воздушных форсунок
- электронное включение водяного насоса
- датчик уровня воды
- слив-перелив
- основание ванны
- покрытие ванны

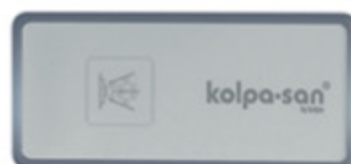



Vital massage system

Vital Massage Systeme
Système de massage Vital
Массажная система Vital

System functions:

- air pump
- water pump
- super water jets
- air jets
- 2 additional water microjets
- 6 water microjets with switch
- airflow regulator min-max
- electronic switch for water and air pump
- water level sensor
- chromotherapy light
- ozone
- Interval regulation for water
- oscillating regulation for air
- heater for maintaining water temperature
- programming the desired water temperature
- overflow set
- bathtub support frame
- bathtub panel (for specific types)

Fonctions du système:

- pompe à air
- pompe hydraulique
- super jets hydrauliques
- jets d'air
- deux micro-jets hydrauliques additionnels
- 6 microjets hydrauliques avec interrupteur
- régulateur de débit d'air min - max
- interrupteur électronique pour la pompe à air et à eau
- senseur pour le niveau d'eau
- lumière avec la chromothérapie
- ozone
- régulation à intervalles pour l'eau
- régulation oscillatoire de l'air
- chauffe-eau pour maintenir la température de l'eau
- programmation de la température voulue de l'eau
- bonde d'évacuation et un trop-plein
- cadre de maintien de la baignoire
- tablier de façade (pour les modèles déterminés)

Systemfunktionen:

- Luftpumpe
- Wasserpumpe
- Superwasserdüsen
- Luftdüsen
- 2 zusätzliche Wassermikrodüsen
- 6 Wassermikrodüsen mit Schaltung
- Luftfluss Regulator Min - Max
- elektronische Einschaltung für die Wasser und die Luftpumpe
- Sensor für das Wasserniveau
- Licht mit Chromotherapie
- Ozon
- Intervallregulierung für das Wasser
- Schwingregulierung für die Luft
- Heizkörper, um die Wassertemperatur zu halten
- Programmierung der gewünschten Wassertemperatur
- Ausfluss - Durchflussgarnitur
- Badewannenuntergestell
- Badewannen Schürze (für bestimmte Artikel)

Состав системы:

- воздушный насос
- водяной насос
- супер водяных форсунок
- воздушных форсунок
- 2 дополнительные водяные микро-форсунки
- 6 водяных микро-форсунок с переключателем
- регулятор потока воздуха мин.- макс.
- электронное включение водяного и воздушного насоса
- датчик уровня воды
- лампочки с хромотерапией
- озон
- интервальный регулятор для воды
- регулятор воздуха
- нагреватель для поддержания температуры воды
- программирование требуемой температуры воды
- слив-перелив
- основание ванны
- покрытие ванны (некоторые модели)

- OPTIONS FOR CERTAIN BATHTUB MODELS:
- OPTIONEN FÜR BESTIMMTE BADEWANNENMODELLE:
- OPTIONS POUR CERTAINS MODÈLES DE BAIGNOIRES:
- ВАРИАНТЫ ДЛЯ ОПРЕДЕЛЕННЫХ ТИПОВ ВАНН:





Luxus + massage system (GAIA 160, SAMSON 180)

Luxus + Massage Systeme (GAIA 160, SAMSON 180)

Système de massage Luxus + (GAIA 160, SAMSON 180)

Люкс + массажная система (ГАИА 160, САМСОН 180)

System functions:

- air pump
- water pump
- micro water jets
- air jets
- super water jets
- 2 selectors for micro water jets
- 2 air flow regulators min-max
- electronic switch for the air and air pump, light, chromotherapy filtration and heating the water
- water level sensor
- light with chromotherapy
- installed filter for water filtration
- heater for maintaining water temperature
- programming the desired water temperature
- overflow set
- bathtub support frame
- bathtub panel (for specific types)

Systemfunktion:

- Luftpumpe
- Wasserpumpe
- Mikro-Wasserdüsen
- Luftdüsen
- 8 Hochleistungswasserdüsen
- 2 Umschalter für Mikro-Wasserdüsen
- 2x Luftdurchflussregler Min - Max
- elektronische Einschaltung für Wasser- und Luftpumpen, Licht, Chromotherapie, Filteranlage und Wasserheizung
- Sensor für das Wasseriveau
- Chromotherapie-Licht
- Wasserfilter
- Wasserheizkörper
- Wassertemperatur-Programmierung
- Überlaufgarnitur
- Untergestell
- Schürze (für bestimmte Modelle)

- OPTIONS FOR CERTAIN BATHTUB MODELS:
- OPTIONEN FÜR BESTIMMTE MODELLE VON BADEWANNEN:
- OPTIONS POUR CERTAINS MODÈLES DE BAIGNOIRES:
- ВАРИАНТЫ ДЛЯ ОПРЕДЕЛЕННЫХ ТИПОВ ВАНН:

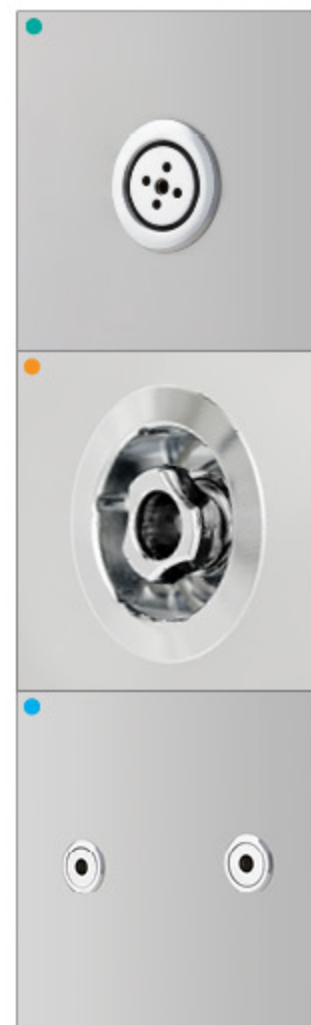

Fonctions du système:

- pompe à air
- pompe hydraulique
- micro jets hydrauliques
- jets d'air
- 8 jets hydrauliques à haute puissance
- 2 commutateurs pour les micro buses d'eau
- 2x réglage d'air min - max
- interrupteur électronique pour les pompes à air et à eau, la lumière, la chromothérapie la filtration et le chauffage de l'eau
- senseur pour le niveau d'eau
- lumière avec la chromothérapie
- filtre d'eau
- chauffage d'eau
- programmation de la température voulue de l'eau
- bonde d'évacuation et un trop-plein
- cadre de maintien de la baignoire
- tablier de façade (pour les modèles déterminés)

Состав системы:

- воздушный насос
- водяной насос
- микро водных форсунок
- воздушных форсунок
- 8 водных супер форсунок
- 2 переключателя для микро водных форсунок
- 2x регулятор потока воздуха мин. – макс.
- электронное включение водяного и воздушного насоса, лампочки, хромотерапии, фильтрация и подогрева воды
- датчик уровня воды
- лампочки с хромотерапией
- установленный фильтр для фильтрации воды
- нагреватель для поддержания температуры воды
- программирование требуемой температуры воды
- слив-перелив
- основание ванны
- покрытие ванны

LUXUS +



GAIA 160



SAMSON 180



Vital massage system

Vital Massage Systeme
Système de massage Vital
Массажная система Vital



ANTISLIP

Advantages of the ANTISLIP coating

- Non-slip surface in shower trays and bathtubs
- Developed for bathrooms, wellness and hotel bathrooms

Vorteile RUTSCHFESTE (ANTISLIP) Beschichtung

- rutschfeste Oberfläche bei der Verwendung der Dusch- bzw. Badewannen
- entwickelt für Bade- oder Wellnessräume und Hotelbadezimmer

Les avantages du revêtement ANTISLIP (ANTIDÉRAPANT)

- une surface antidérapante du receveur de douche ou de la baignoire, lors de l'utilisation
- développé pour les salles de bains ou de bien-être et pour les salles de bains d'hôtel

Преимущества ANTISLIP (антискользящего) покрытия

- нескользящая поверхность во время пользования ванной или душевой кабиной
- разработано для ванн и велнес помещений, а также для гостиничных ванн комнат

Improved safety:

- When entering or exiting the shower or bath tub
- During showering and bathing

Erhöhte Sicherheit:

- Beim Ein- und Aussteigen in und aus der Dusch- bzw. Badewanne
- während des Badens und Duschens

Une plus grande sécurité:

- lors de l'entrée et de la sortie du receveur de douche ou du baignoire
- en prenant le bain et la douche

Повышенная безопасность:

- во время входа и выхода из душа или ванны
- во время купания или принятия душа

Adam & Eva-FS 190 x 120 / Адам & Ева-ФС 190 x 120

- Oval bathtub, freestanding, with overflow assembly.
- The bathtub and side panels from a single element.
- Ovale Badewanne, freistehend, mit Überlaufgarnitur.
- Badewanne und Belag aus einem Teil.
- Baignoire ovale autonome avec ensemble de débordement. Baignoire et caisson en une pièce.
- Овальная автономная ванна с системой слива.
- Ванна и обшивка являются одним целым.

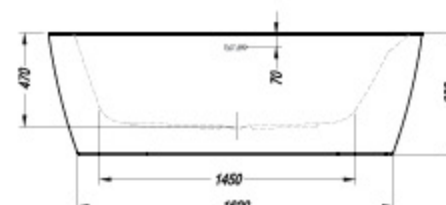
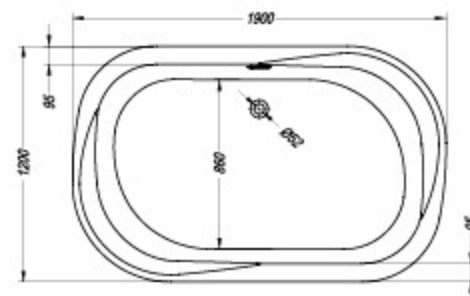
Adam & Eva-FS 190 x 120
A B Vol.
1900 1200 450 l



› 120-219 › 20-29 › 290 › 291 › 295



Comodo-FS 185 x 90 / Цомодо-ФС 185 x 90

- Oval bathtub, freestanding, with overflow assembly. The bathtub and side panels from a single element.
- Ovale Badewanne, freistehend, mit Überlaufgarnitur. Badewanne und Belag aus einem Teil.
- Baignoire ovale autonome avec ensemble de débordement. Baignoire et caisson en une pièce.
- Овальная автономная ванна с системой слива. Ванна и обшивка являются одним целым.



	A	B	Vol.
• • Comodo-FS 185 x 90	1850	900	285 l

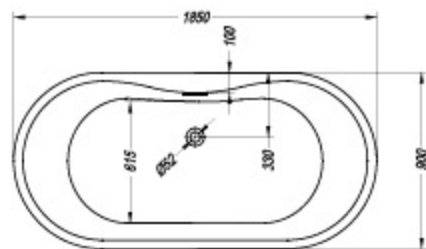

Massage system
 Massagesystem
 Système de l'hydro massage
 Массажная система

› 020



> 120-219 > 20-29 > 290 > 291 > 295



White-Antracit



Blanche-FS 180 x 85 / Бланче-ФС 180 x 85

- Oval freestanding Kerrock bathtub, outflow set with the UP&DOWN system.
- Ovale Badewanne aus Kerrock, freistehend, Ablaufgarnitur mit UP & DOWN System.
- Baignoire autonome ovale Kerrock, dispositif de vidage avec système UP&DOWN.
- Овальная ванна из Керрокса, со сливом, системой UP&DOWN (вверх и вниз).



	A	B	Vol.
• Blanche-FS 180 x 85	1800	850	280 l

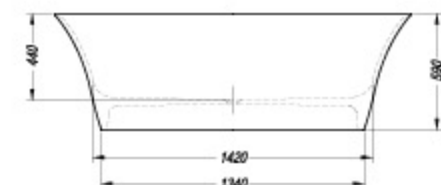
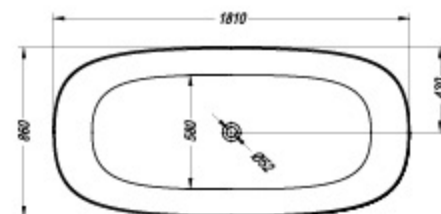



› 120-219 › 20-29 › 290 › 291 › 295



White-Black



White-Red



White-Blue



White-Green



Marilyn-FS 180x90 / Марилын-ФС 180x90

- Bathtub, free-standing, with overflow assembly.
The bathtub and side panels from a single element.
- Badewanne, freistehend, mit Überlaufgarnitur.
Badewanne und Verkleidung in einem.
- Baignoire autonome avec ensemble de débordement.
Baignoire et caisson en une pièce.
- Автономная ванна с системой слива.
Ванна и обшивка являются одним целым.



	A	B	Vol.
• • Marilyn-FS 180 x 90	1800	900	260 l

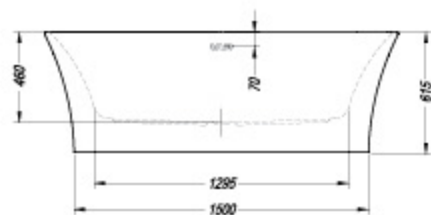
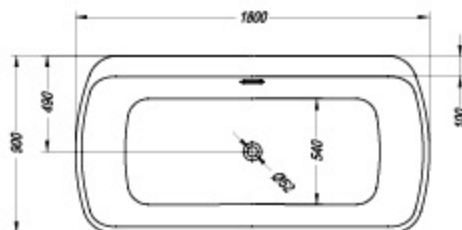

Accessories For bathtubs
Zubehör für Badewannen
Accessoires pour baignoires
Аксессуары для ванн

› 291



› 120-219 › 20-29 › 290 › 291 › 295



White-Black



White-Red



White-Blue



White-Green



Eroica-FS 180 x 80 / Ероица-ФС 180 x 80

- Oval bathtub, freestanding, with overflow assembly. The bathtub and side panels from a single element.
- Ovale Badewanne, freistehend, mit Überlaufgarnitur. Badewanne und Belag aus einem Teil.
- Baignoire ovale autonome avec ensemble de débordement. Baignoire et caisson en une pièce.
- Овальная автономная ванна с системой слива. Ванна и обшивка являются одним целым.



A B Vol.

Eroica-FS 180 x 80 1800 800 275 l

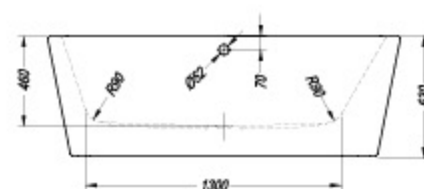
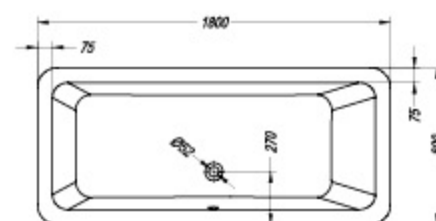



> 120-219 > 20-29 > 290 > 291 > 295



White-Black



White-Red



White-Blue



White-Green



Adonis-FS 180 x 80 / Адонис-ФС 180 x 80

- Oval bathtub, freestanding, with overflow assembly. The bathtub and side panels from a single element.
- Ovale Badewanne, freistehend, mit Überlaufgarnitur. Badewanne und Belag aus einem Teil.
- Baignoire ovale autonome avec ensemble de débordement. Baignoire et caisson en une pièce.
- Овальная автономная ванна с системой слива. Ванна и обшивка являются одним целым.



	A	B	Vol.
• • Adonis-FS 180 x 80	1800	800	235 l

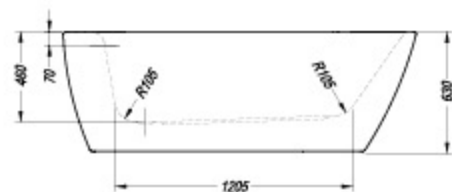
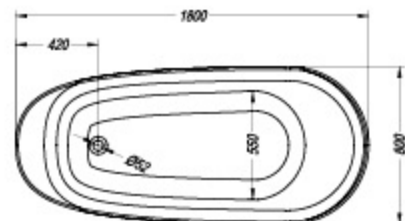

Accessories
Zubehör
Accessoires
Аксессуары для
ванной комнаты

> 282



> 120-219 > 20-29 > 290 > 291 > 295



White-Black



White-Red



White-Blue

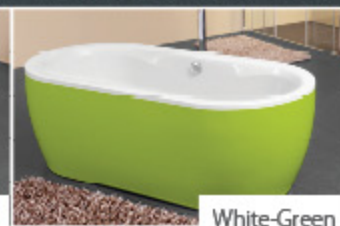

White-Green



Siris-FS 178x88 / Сирис-ФС 178x88

- Oval bathtub, freestanding, with overflow assembly.
The bathtub and side panels from a single element.
- Ovale Badewanne, freistehend, mit Überlaufgarnitur.
Badewanne und Belag aus einem Teil.
- Baignoire ovale autonome avec ensemble de débordement. Baignoire et caisson en une pièce.
- Овальная автономная ванна с системой слива.
Ванна и обшивка являются одним целым.



Siris-FS 178 x 88

A

B

Vol.

1780

880

285 l

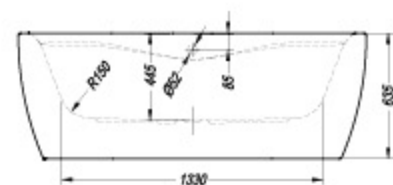
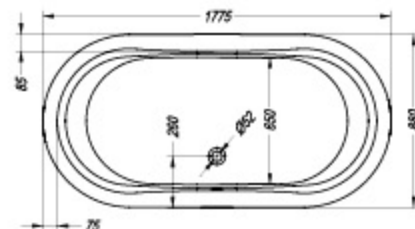



PANDORA bathtub-FS 173, 163



› 120-219 › 20-29 › 290 › 291 › 295



**Pandora bathtub-FS 173x78, 163x68 /
Пандора батhtub-ФС 173x78, 163x68**

- Oval bathtub, freestanding, outflow set with the UP&DOWN system.
- Ovale Badewanne, freistehend, Ablaufgarnitur mit UP & DOWN System.
- Baignoire ovale autonome, dispositif de vidage avec système UP&DOWN.
- Овальная автономная ванна с системой слива, системой UP&DOWN (вверх и вниз).



	A	B	C	D	Vol.
• Pandora bathtub-FS 173 x 78	1730	780	1360	630	285 l
• Pandora bathtub-FS 163 x 68	1630	680	1260	530	230 l

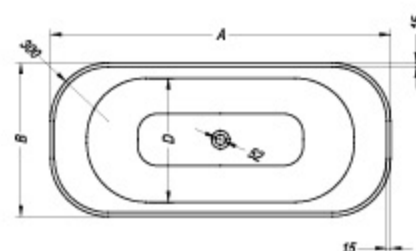

Protective paint
Schutzanstrich
Revêtement de protection
Защитное покрытие

› 295



White-Black



White-Red



White-Blue



White-Green



Dalia-FS 170x80 / Далия-ФС 170x80

- Oval bathtub, freestanding, with overflow assembly. The bathtub and side panels from a single element.
- Ovale Badewanne, freistehend, mit Überlaufgarnitur. Badewanne und Belag aus einem Teil.
- Baignoire ovale autonome avec ensemble de débordement. Baignoire et caisson en une pièce.
- Овальная автономная ванна с системой слива. Ванна и обшивка являются одним целым.



	A	B	Vol.
• Dalia-FS 170 x 80	1700	800	275 l

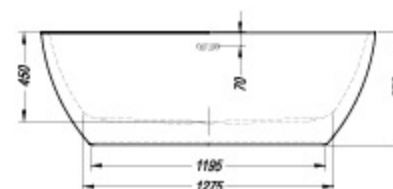
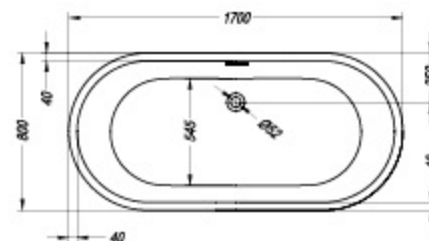



Dream-SP 180 x 80 / Дреам-СП 180 x 80

- oval bathtub for wall installation with an overflow fitting. The bathtub and the panel made of a single piece.
- Ovale Badewanne für die Montage an der Wand mit einer Überlaufgarnitur. Badewanne und Verkleidung aus einem Teil.
- Baignoire ovale à encastrier le long du mur, avec l'ensemble de remplissage. La baignoire et le revêtement sont fabriqués en une pièce.
- Овальная ванна, для пристенной установки. Панель интегрирована в корпус Ванны.

	A	B	Vol.	
• •	Dream-SP 180 x 80	1800	800	245 l

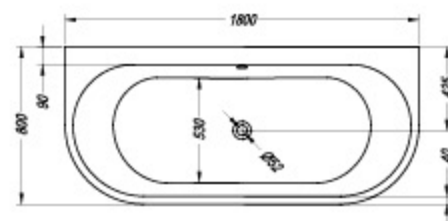



Opera 180 / Опера 180

- round massage bathtub with a handle, for built-in installation.
- Runde Massagebadewanne mit Griff, für den Einbau.
- baignoire de massage ronde avec poignée, à encastrer.
- круглая гидромассажная ванна с ручкой, для встраивания.



Opera 160 /O / Опера 180/O

- round massage bathtub with a handle and a panel.
- Runde Massagebadewanne mit Griff und Verkleidung.
- Baignoire de massage ronde avec poignée et revêtement.
- Круглая гидромассажная ванна с ручкой и панелями.



	A	B	Vol.	
•	Opera 180 x 180	1800	1800	570 l
• •	Opera 180 x 180/O	1800	1800	570 l

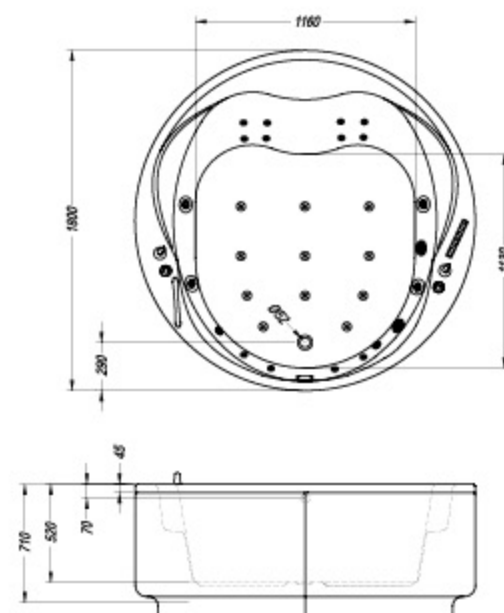



Gala 160 / Гаиa 160

- corner massage bathtub for built-in installation with a single-hand mixer and a shower handle.
- Eckmassagebadewanne für den Einbau mit einarmiger Armatur und Duschgriff.
- baignoire de massage d'angle à encastrer, avec robinet à une manette et manette de douche.
- угловая гидромассажная ванна для встраивания, со встроенным смесителем.

Gala 160 /O / Гаиa 160/O

- corner massage bathtub with a panel, single-hand mixer and shower handle.
- Eckmassagebadewanne mit Verkleidung, einarmiger Armatur und Duschgriff
- baignoire de massage d'angle avec revêtement, robinet à une manette et manette de douche
- угловая гидромассажная ванна для встраивания, со встроенным смесителем и панелью



A

B

Vol.

•	•	Gaia 160 x 160	1600	1600	550l
•	•	Gaia 160 x 160/O	1600	1600	550l

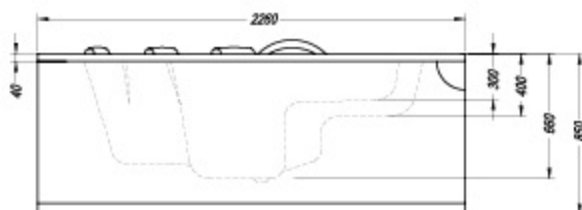
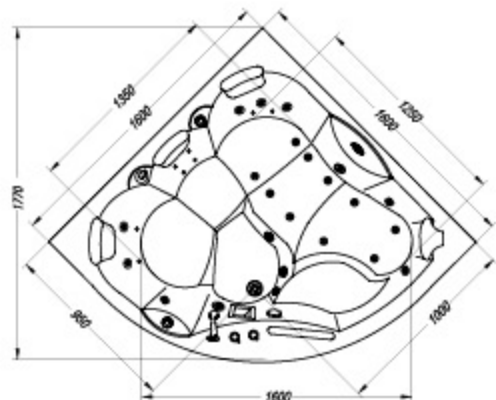

**Swan 160 / Swan 160**

- Corner bathtub, built-in.
- Eckbadewanne, zum Einbau.
- baignoire d'angle à encastrer.
- угловая ванна, встраиваемая.

**Swan 160/O / Swan 160/O**

- Corner bathtub with panel.
- Eckbadewanne mit Schürze.
- baignoire d'angle avec tablier de façade.
- угловая ванна с панелью.



		A	B	Vol.
•	Swan 160 x 160	1600	1600	410 l
• •	Swan 160/O	1600	1600	410 l



- seat
- Sitz
- siège
- сиденье

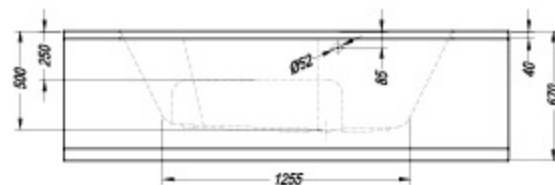
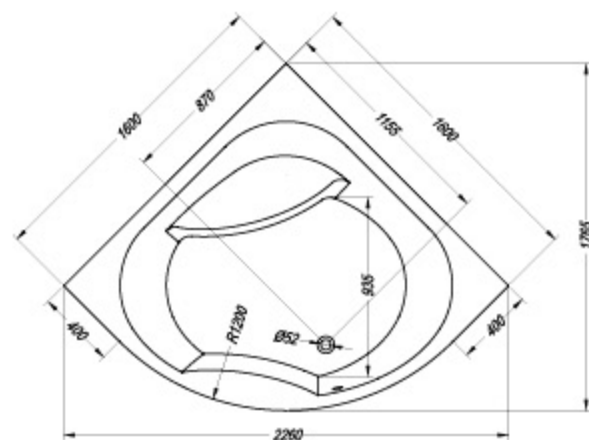









 > 120-219 > 20-29 > 290 > 291 > 295



Orfeo 150, 140/ Орфео 150, 140

- Corner bathtub, built-in.
- Eckbadewanne, zum Einbau.
- baignoire d'angle à encastrer.
- угловая ванна, встраиваемая.



Orfeo 150/O, 140/O / Орфео 150/O, 140/O

- Corner bathtub with panel.
- Eckbadewanne mit Schürze.
- baignoire d'angle avec tablier de façade.
- угловая ванна с панелью.



		A	B	Vol.
• •	Orfeo 150 x 150 (O)	1500	865	270 l
• •	Orfeo 140 x 140 (O)	1400	765	200 l



- seat
- Sitz
- siège
- сиденье

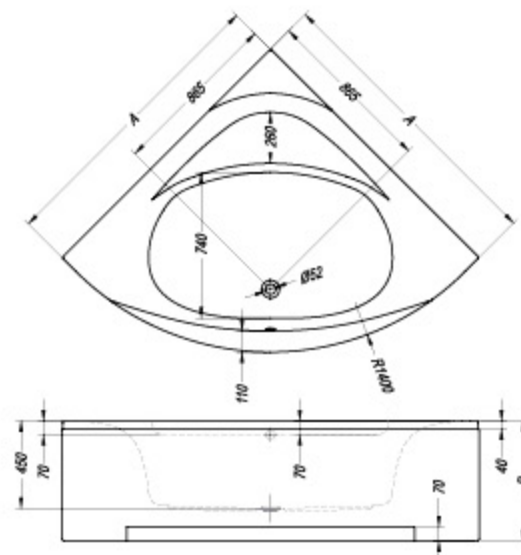

**Largo 150 / Ларго 150**

- Corner bathtub, built-in.
- Eckbadewanne, zum Einbau.
- baignoire d'angle à encastrer.
- угловая ванна, встраиваемая.

**Largo 150/O / Ларго 150/O**

- Corner bathtub with panel.
- Eckbadewanne mit Schürze.
- baignoire d'angle avec tablier de façade.
- угловая ванна с панелью.

		A	B	Vol.
• •	Largo 150 x 150	1500	1500	335 l
• • •	Largo 150/O	1500	1500	335 l

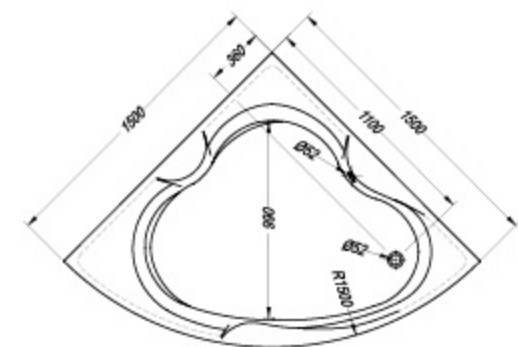

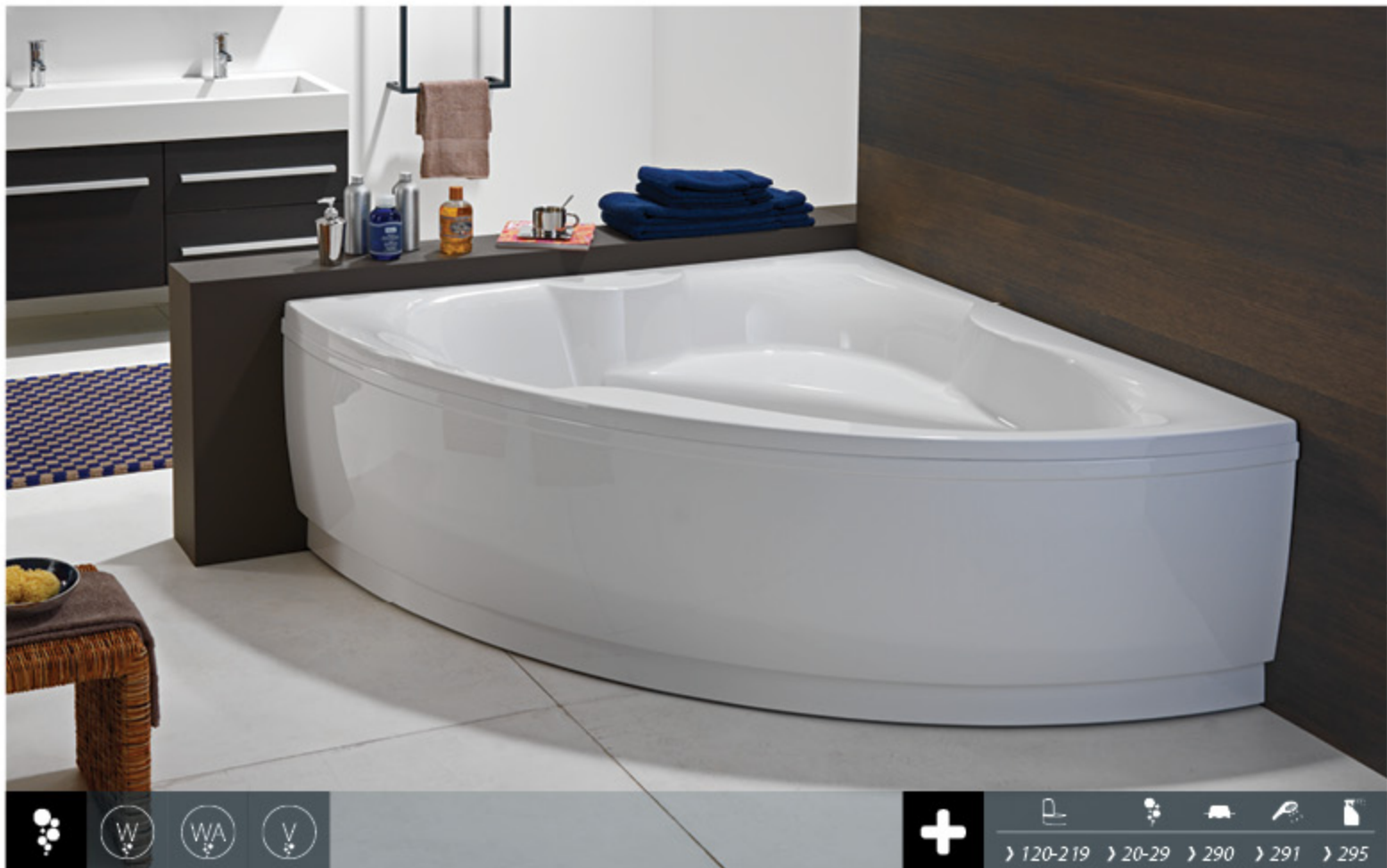

› 120-219 › 20-29 › 290 › 291 › 295

ALBA 150

Alba 150/ Алба 150

- Corner bathtub, built-in.
- Eckbadewanne, zum Einbau.
- baignoire d'angle à encastrer.
- угловая ванна, встраиваемая.



	A	B	Vol.	
• •	Alba 150 x 150	1500	1500	280 l
• • •	Alba 150/O	1500	1500	280 l

Alba 150/O / Алба 150/O

- Corner bathtub with panel.
- Eckbadewanne mit Schürze.
- baignoire d'angle avec tablier de façade.
- угловая ванна с панелью.



- seat
- Sitz
- siège
- сиденье

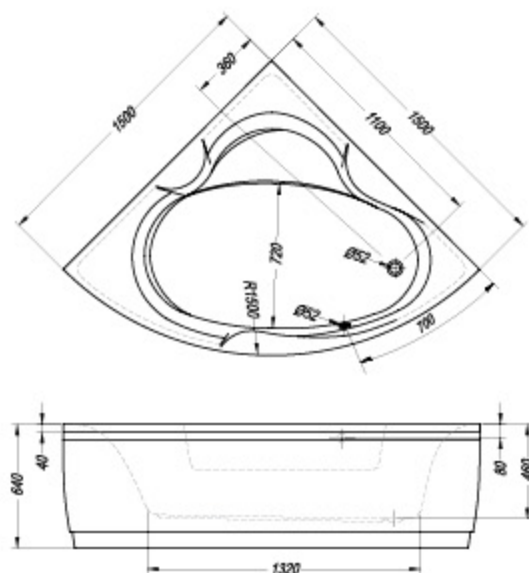



LOCO 150

**Loco 150 / Локо 150**

- Corner bathtub, built-in.
- Eckbadewanne, zum Einbau.
- baignoire d'angle à encastrer.
- угловая ванна, встраиваемая.

**Loco 150/O / Локо 150/O**

- Corner bathtub with panel.
- Eckbadewanne mit Schürze.
- baignoire d'angle avec tablier de façade.
- угловая ванна с панелью.

	A	B	Vol.	
• • •	Loco 150 x 150	1500	1500	385 l
• • •	Loco 150/O	1500	1500	385 l



- seat
- Sitz
- siège
- сиденье

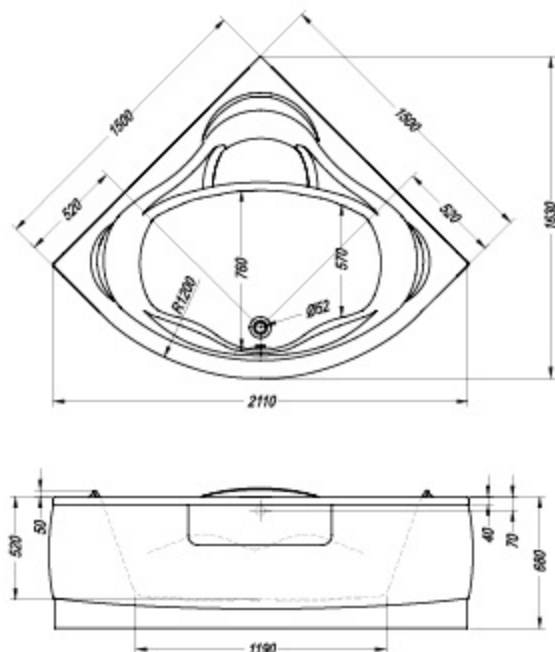



› 120-219 › 20-29 › 290 › 291 › 295

EVELIN bathtub 140, 120

Evelin 140, 120 / Евелин батhtub 140, 120

- Corner bathtub, built-in.
- Eckbadewanne, zum Einbau.
- baignoire d'angle à encastrer.
- угловая ванна, встраиваемая.



	A	B	C	D	Vol.
• Evelin bathtub 140 x 140 (O)	1400	1400	1180	610	225 l
• Evelin bathtub 120 x 120 (O)	1200	1200	1010	525	165 l

Evelin 140/O, 120/O / Евелин батhtub 140/O, 120/O

- Corner bathtub with panel.
- Eckbadewanne mit Schürze.
- baignoire d'angle avec tablier de façade.
- угловая ванна с панелью.

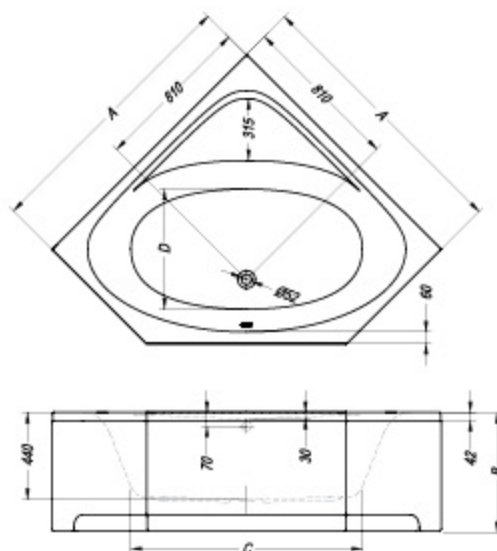



> 120-219 > 20-29 > 290 > 291 > 295

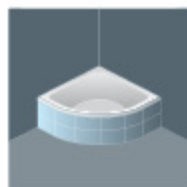

Divante 140 / Диванте 140

- Corner bathtub, built-in.
- Eckbadewanne, zum Einbau.
- baignoire d'angle à encastrer.
- угловая ванна, встраиваемая.



Divante 140/O / Диванте 140/O

- Corner bathtub with panel.
- Eckbadewanne mit Schürze.
- baignoire d'angle avec tablier de façade.
- угловая ванна с панелью.

P	W	A	B	Vol.	
•	•	Divante 140 x 140	1400	1400	240 l
•	•	Divante 140/O	1400	1400	240 l



- seat
- Sitz
- siège
- сиденье

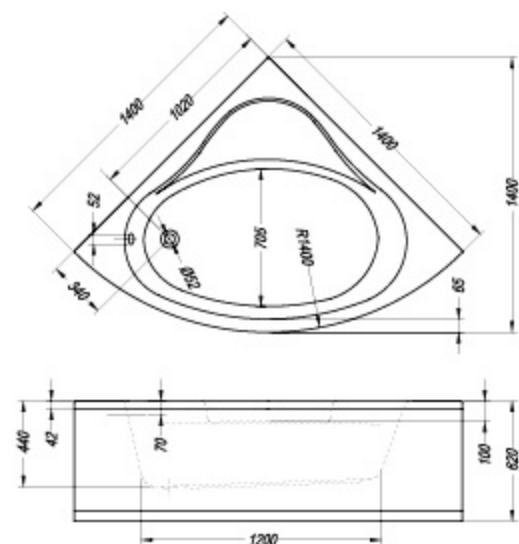

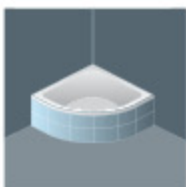

Royal 130, 120 / Роял 130, 120

- Corner bathtub, built-in.
- Eckbadewanne, zum Einbau.
- baignoire d'angle à encastrer.
- угловая ванна, встраиваемая.



Royal 130/O, 120/O / Роял 130/O, 120/O

- Corner bathtub with panel.
- Eckbadewanne mit Schürze.
- baignoire d'angle avec tablier de façade.
- угловая ванна с панелью.



		A	B	Vol.
• •	Royal 130 x 130 (O)	1300	1300	220 l
•	Royal 120 x 120 (O)	1200	1200	180 l



- seat
- Sitz
- siège
- сиденье

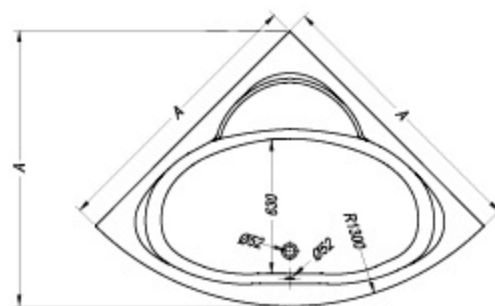



CHAD 170 x 120

**Chad 170 x 120 /****Чад 170 x 120**

- Bathtub, built-in.
- Badewanne, zum Einbau.
- baignoire à encastrer.
- встраиваемая ванна.

**Chad 170 x 120/O /****Чад 170 x 120/O**

- Bathtub with panel.
- Badewanne mit Schürze.
- baignoire avec tablier de façade.
- ванна с панелью.



- seat
- Sitz
- siège
- сиденье

		A	B	Vol.
• •	Chad 170 x 120	1700	1200	325 l
• • •	Chad 170 x 120/O	1700	1200	325 l



Chad-L 170 x 120



Chad-R 170 x 120

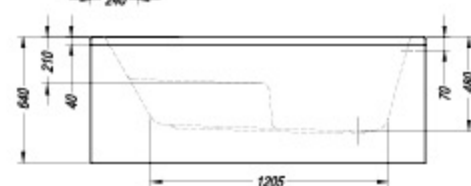
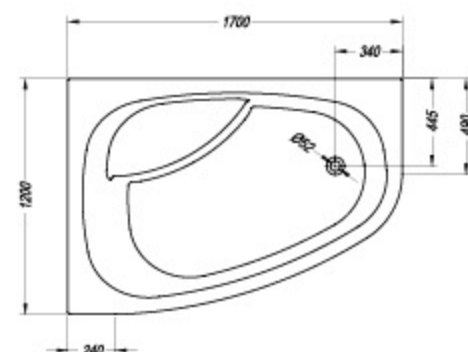
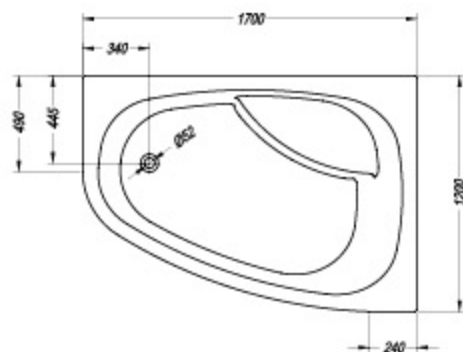

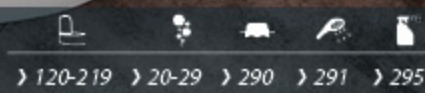

> 120-219 > 20-29 > 290 > 291 > 295



Lulu 170x110 / Лулу 170x110

- Bathtub, built-in.
- Badewanne, zum Einbau.
- baignoire à encastrer.
- встраиваемая ванна.



Lulu 170x110/O / Лулу 170x110/O

- Bathtub with panel.
- Badewanne mit Schürze.
- baignoire avec tablier de façade.
- ванна с панелью.



- seat
- Sitz
- siège
- сиденье



		A	B	Vol.
• •	Lulu 170 x 110	1700	1100	350l
• • •	Lulu 170 x 110/O	1700	1100	350l



Lulu-L 170x110



Lulu-R 170x110

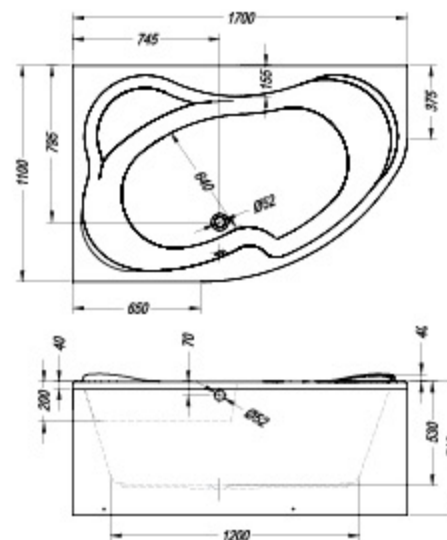
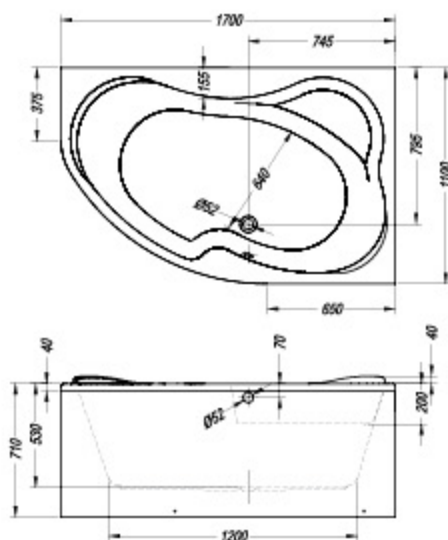



**Beatrice 170x110(x70) /
Беатрис 170x110(x70)**

- Bathtub, built-in.
- Badewanne, zum Einbau.
- baignoire à encastrer.
- встраиваемая ванна.



**Beatrice 170x110(x70)/O /
Беатрис 170x110(x70)/O**

- Bathtub with panel.
- Badewanne mit Schürze.
- baignoire avec tablier de façade.
- ванна с панелью.

P	•		A	B	Vol.
•	•	Beatrice 170 x 110	1700	1100(700)	305 l
•	•	Beatrice 170 x 110/O	1700	1100(700)	305 l



Beatrice-L 170x110(x70)



Beatrice-R 170 x110(x70)

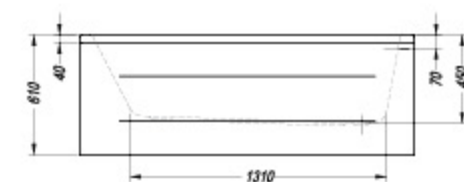
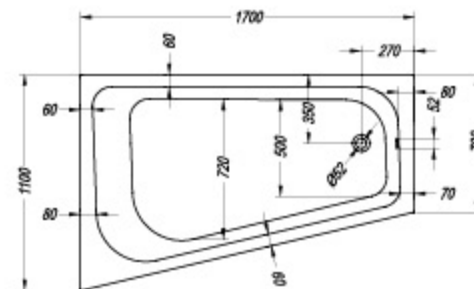
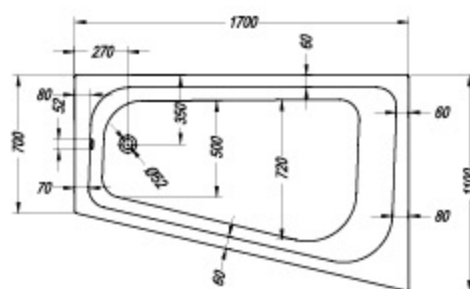



Calando 160, 150 / Цаландо 160, 150

- Bathtub, built-in.
- Badewanne, zum Einbau.
- baignoire à encastrer.
- встраиваемая ванна.



Calando 160, 150 / Цаландо 160, 150/O

- Bathtub with panel.
- Badewanne mit Schürze.
- baignoire avec tablier de façade.
- ванна с панелью.



- seat
- Sitz
- siège
- сиденье

		A	B	Vol.
• •	Calando 160 x 90	1600	900	205 l
• • •	Calando 160 x 90(O)	1600	900	205 l
• •	Calando 150 x 85	1500	850	180 l
• • •	Calando 150 x 85(O)	1500	850	180 l



Calando-L 160x90, 150x85



Calando-R 160x90, 150x85

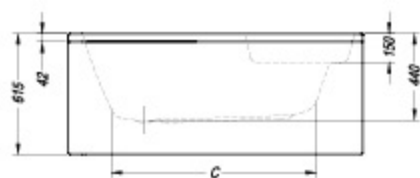
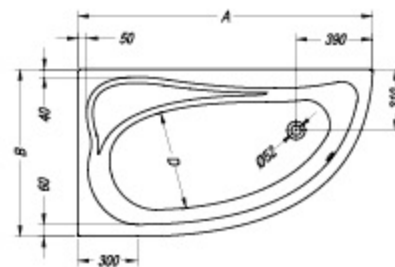
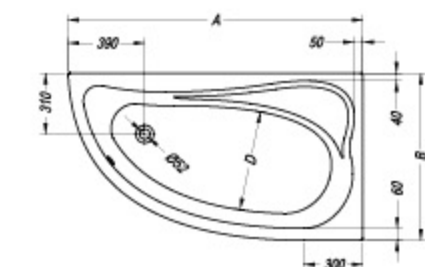

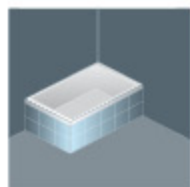
**Rapido 200 x 90 / Рапидо 200 x 90**

- Bathtub, built-in.
- Badewanne, zum Einbau.
- baignoire à encastrer.
- встраиваемая ванна.



	A	B	C	D	Vol.	
• •	Rapido 200x 90	2000	900	1470	560	360 l
• • •	Rapido 200 x 90/O	2000	900	1470	560	360 l

**Rapido 200 x 90/O / Рапидо 200 x 90/O**

- Bathtub with panel.
- Badewanne mit Schürze.
- baignoire avec tablier de façade.
- ванна с панелью.

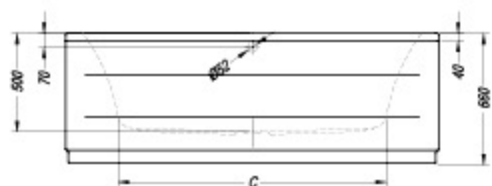
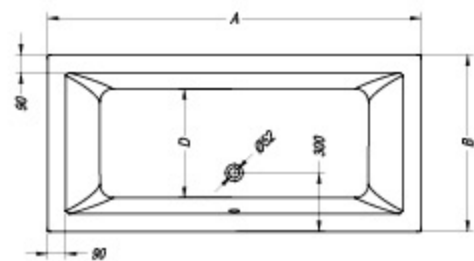



Adam & Eva 195 x 125 / Адам & Ева 195 x 125

- Bathtub, built-in.
- Badewanne, zum Einbau.
- baignoire à encastrer.
- встраиваемая ванна.



Adam & Eva 195 x 125/O / Адам & Ева 195 x 125/O

- Bathtub with panel.
- Badewanne mit Schürze.
- baignoire avec tablier de façade.
- ванна с панелью.

			A	B	Vol.
•	•	Adam & Eva 195 x 125	1950	1250	450 l
•	•	Adam & Eva 195 x 125 / O	1950	1250	450 l

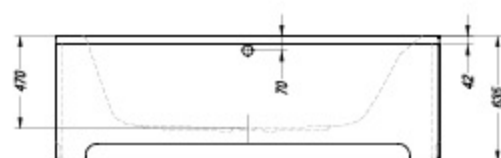
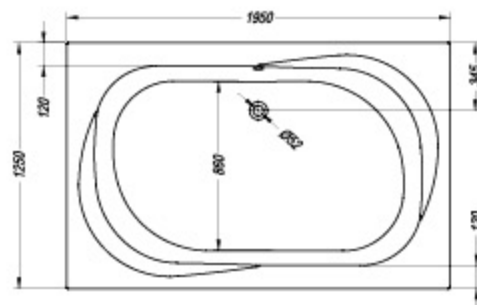

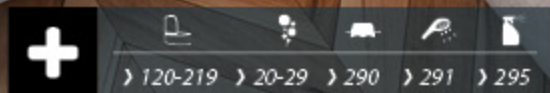

NABUCCO 190

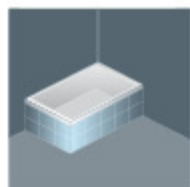

Nabucco 190 x 120 / Набукко 190 x 120

- Bathtub, built-in.
- Badewanne, zum Einbau.
- baignoire à encastrer.
- встраиваемая ванна.



Nabucco 190 x 120/O / Набукко 190 x 120/O

- Bathtub with panel.
- Badewanne mit Schürze.
- baignoire avec tablier de façade.
- ванна с панелью.

		A	B	Vol.
• •	Nabucco 190 x 120	1900	1200	450 l
• • •	Nabucco 190 x 120/O	1900	1200	450 l

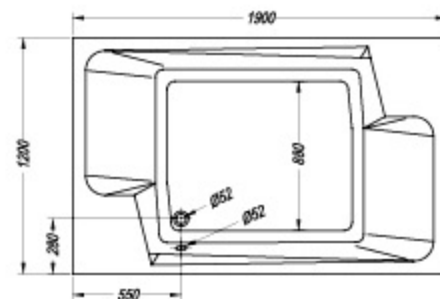



Norma 190 x 95 / Норма 190 x 95

- Bathtub, built-in.
- Badewanne, zum Einbau.
- baignoire à encastrer.
- встраиваемая ванна.



Norma 190 x 95/O / Норма 190 x 95/O

- Bathtub with panel.
- Badewanne mit Schürze.
- baignoire avec tablier de façade.
- ванна с панелью.

		A	B	Vol.
• •	Norma 190 x 95	1900	950	390 l
• • •	Norma 190 x 95/O	1900	950	390 l

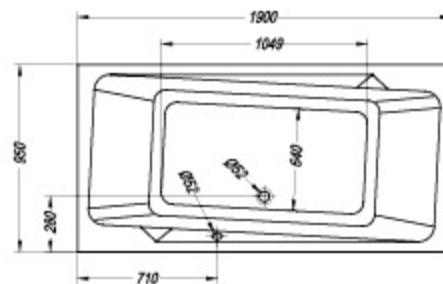

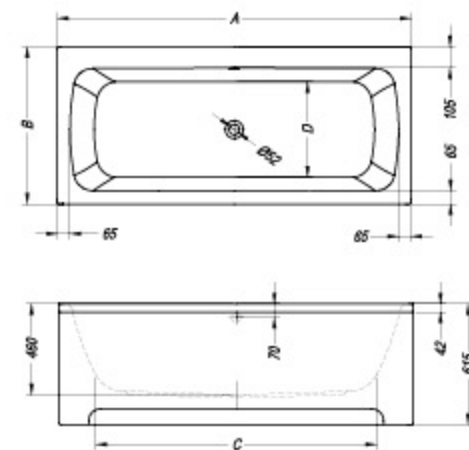

Bell 190, 180, 170

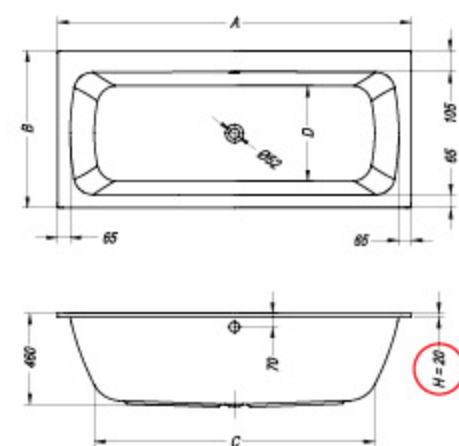

Bell E2 190, 180, 170

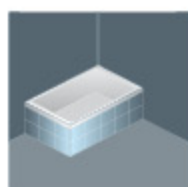

**Bell 190, 180, 170 /
Белл 190, 180, 170**

- Bathtub, built-in.
- Badewanne, zum Einbau.
- baignoire à encastrer.
- встраиваемая ванна.



**Bell 190/O, 180/O, 170/O /
Белл 190/O, 180/O, 170/O**

- Bathtub with panel.
- Badewanne mit Schürze.
- baignoire avec tablier de façade.
- ванна с панелью.

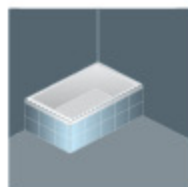

**Bell E2 190, 180, 170 /
Белл E2 190, 180, 170**

- Bathtub, built-in. H = 20mm.
- Badewanne, zum Einbau. H = 20mm.
- baignoire à encastrer. Prevod. H = 20mm.
- встраиваемая ванна. Prevod. H = 20mm.



	A	B	C	D	Vol.	
• •	Bell 190x 90	1900	900	1530	585	325 l
• • •	Bell 190x 90/O	1900	900	1530	585	325 l
• •	Bell 180x 90	1800	900	1430	585	310 l
• • •	Bell 180x 90/O	1800	900	1430	585	310 l
• •	Bell 180x 80	1800	800	1430	485	260 l
• • •	Bell 180x 80/O	1800	850	1430	485	260 l
• •	Bell 170x 80	1700	800	1330	485	240 l
• • •	Bell 170x 80/O	1700	800	1330	485	240 l

P	A	B	C	D	Vol.	
•	Bell E2 190x 90	1900	900	1530	585	325 l
•	Bell E2 180x 90	1800	900	1430	585	310 l
•	Bell E2 180x 80	1800	800	1430	485	260 l
•	Bell E2 170x 80	1700	800	1330	485	240 l



› 120-219 › 20-29 › 290 › 291 › 295



White-Black



White-Cherry



White-Blue



White-Lime

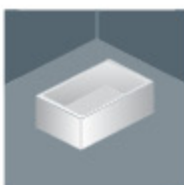

	A	B	C	D	Vol.
Bell 190x 90/40	1900	900	1530	585	325 l
Bell 180x 90/40	1800	900	1430	585	310 l
Bell 180x 80/40	1800	800	1430	485	260 l
Bell 170x 80/40	1700	800	1330	485	240 l

Bell 190/40, 180/40, 170/40 /

Белл 190/40, 180/40, 170/40

- Free-standing bathtub with Kerrock panel.
- freistehende Badewanne mit Schürze aus Kerrock.
- baignoire autonome avec tablier de façade en Kerrock.
- ванна с панелью из керрока, отдельно стоящая.

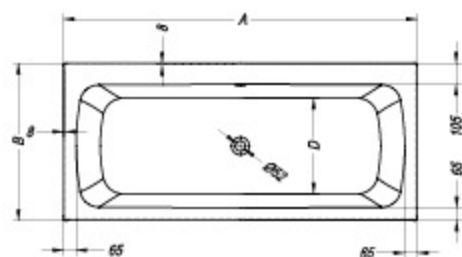

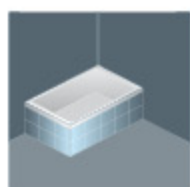
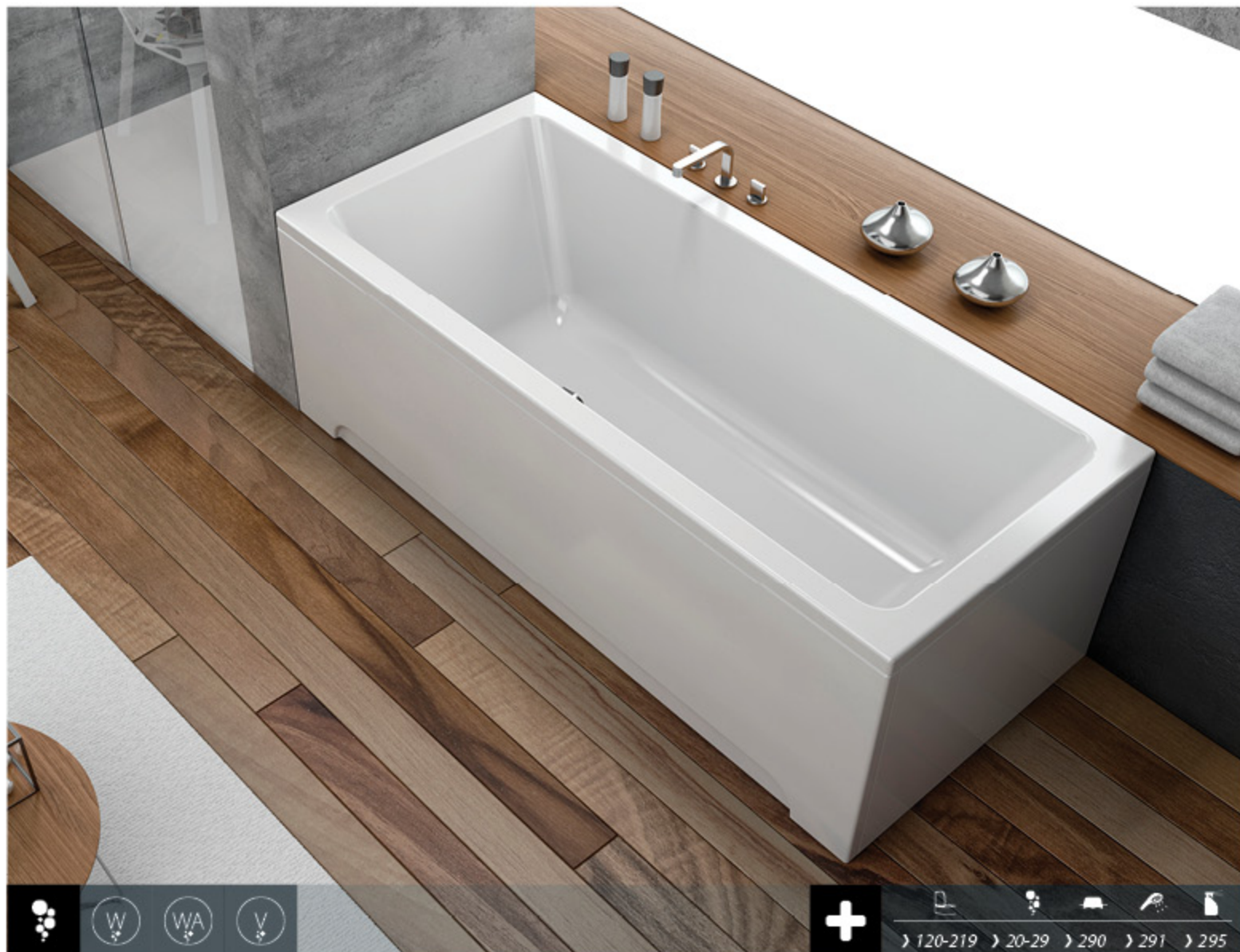
Elektra 190, 180, 170, 160 /
Elektra 190, 180, 170, 160

- Bathtub, built-in.
- Badewanne, zum Einbau.
- baignoire à encastrer.
- встраиваемая ванна.

Elektra 190/O, 180/O, 170/O, 160/O /
Elektra 190/O, 180/O, 170/O, 160/O

- Bathtub with panel.
- Badewanne mit Schürze.
- baignoire avec tablier de façade.
- ванна с панелью.



	A	B	C	D	Vol.
• • Elektra 190 x 90 (O)	1900	900	1345	640	360 l
• • Elektra 180 x 80 (O)	1800	800	1200	540	265 l
• • Elektra 170 x 80 (O)	1700	800	1145	540	245 l
• • • Elektra 170 x 75 (O)	1700	750	1080	490	220 l
• • Elektra 170 x 70 (O)	1700	700	1145	440	200 l
• • • Elektra 160 x 75 (O)	1600	750	970	450	205 l

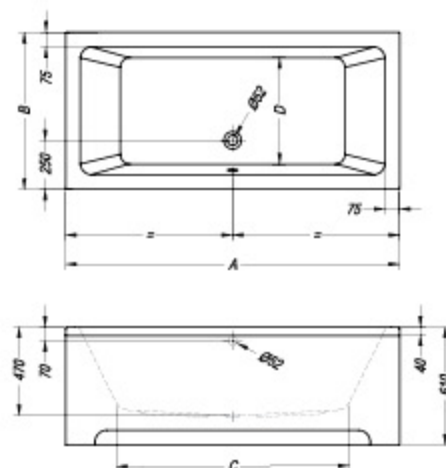



Samson 180 x 160 / Самсон 180 x 160

- Bathtub, built-in.
- Badewanne, zum Einbau.
- baignoire à encastrer.
- встраиваемая ванна.



Samson 180 x 160/20 / Самсон 180 x 160/20

- Bathtub with panel.
- Badewanne mit Schürze.
- baignoire avec tablier de façade.
- ванна с панелью.



		A	B	Vol.
• •	Samson 180 x 160	1800	1600	650 l
• • •	Samson 180 x 160/20	1800	1600	650 l
• • •	Samson 180 x 160/40	1800	1600	650 l



Samson 180 x 160/40 /

Самсон 180 x 160/40

- Free-standing bathtub (4 side panels).
- freistehende Badewanne (4 Frontschürzen).
- baignoire autonome (4 revêtements).
- отдельно стоящая ванна (4 панели).

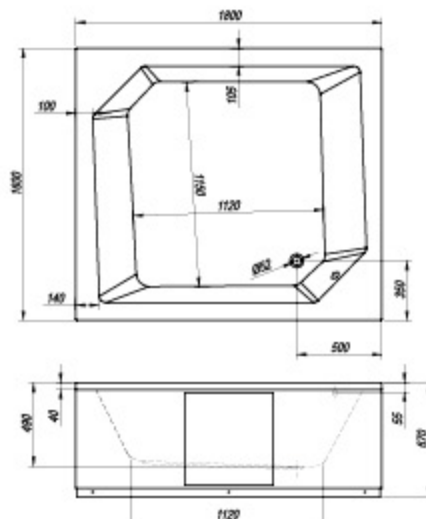

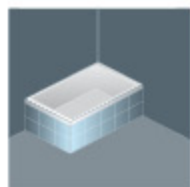

**Pandora bathtub 180, 170 /
Пандора батhtub 180, 170**

- Bathtub, built-in.
- Badewanne, zum Einbau.
- baignoire à encastrer.
- встраиваемая ванна.



**Pandora bathtub 180/O, 170/O /
Пандора батhtub 180/O, 170/O**

- Bathtub with panel.
- Badewanne mit Schürze.
- baignoire avec tablier de façade.
- ванна с панелью.



	A	B	C	D	Vol.
• • Pandora bathtub 180 x 85	1800	850	1330	630	285 l
• • • Pandora bathtub 180 x 85/O	1800	850	1330	630	285 l
• • Pandora bathtub 170 x 75	1700	750	1230	530	230 l
• • • Pandora bathtub 170 x 75/O	1700	750	1230	530	230 l

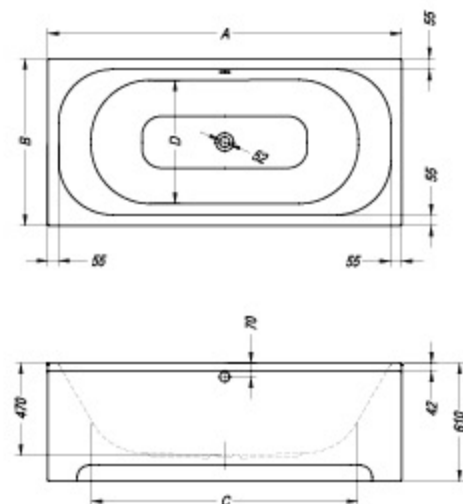



Armida 180 x 80 / Армида 180 x 80

- Bathtub, built-in.
- Badewanne, zum Einbau.
- baignoire à encastrer.
- встраиваемая ванна.



Armida 180 x 80/O / Армида 180 x 80/O

- Bathtub with panel.
- Badewanne mit Schürze.
- baignoire avec tablier de façade.
- vasca da bagno con pannello.
- ванна с панелью.

		A	B	Vol.
• •	Armida 180 x 80	1800	800	280 l
• • •	Armida 180 x 80/O	1800	800	280 l

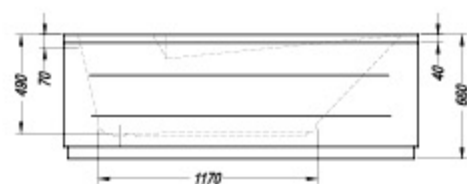
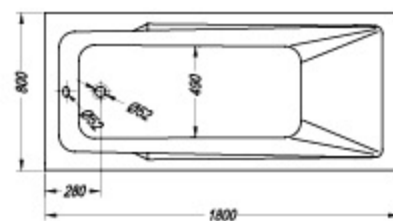

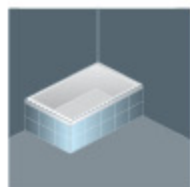
**Aida 180, 170, 160****Аида 180, 170, 160**

- Bathtub, built-in.
- Badewanne, zum Einbau.
- baignoire à encastrer.
- встраиваемая ванна.

**Aida 180/O, 170/O, 160/O****Аида 180/O, 170/O, 160/O**

- Bathtub with panel.
- Badewanne mit Schürze.
- baignoire avec tablier de façade.
- ванна с панелью.



		A	B	C	D	Vol.	
•	•	Aida 180x 80	1800	800	1150	525	250 l
•	•	Aida 180x 80/O	1800	800	1150	525	250 l
•	•	Aida 170x 75	1700	750	1085	490	205 l
•	•	Aida 170x 75/O	1700	750	1085	490	205 l
•	•	Aida 160x 75	1600	750	990	490	195 l
•	•	Aida 160x 75/O	1600	750	990	490	195 l

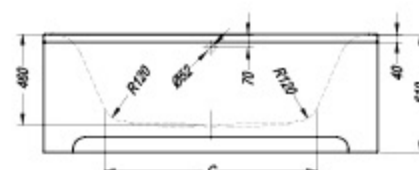
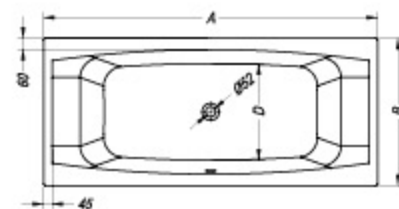

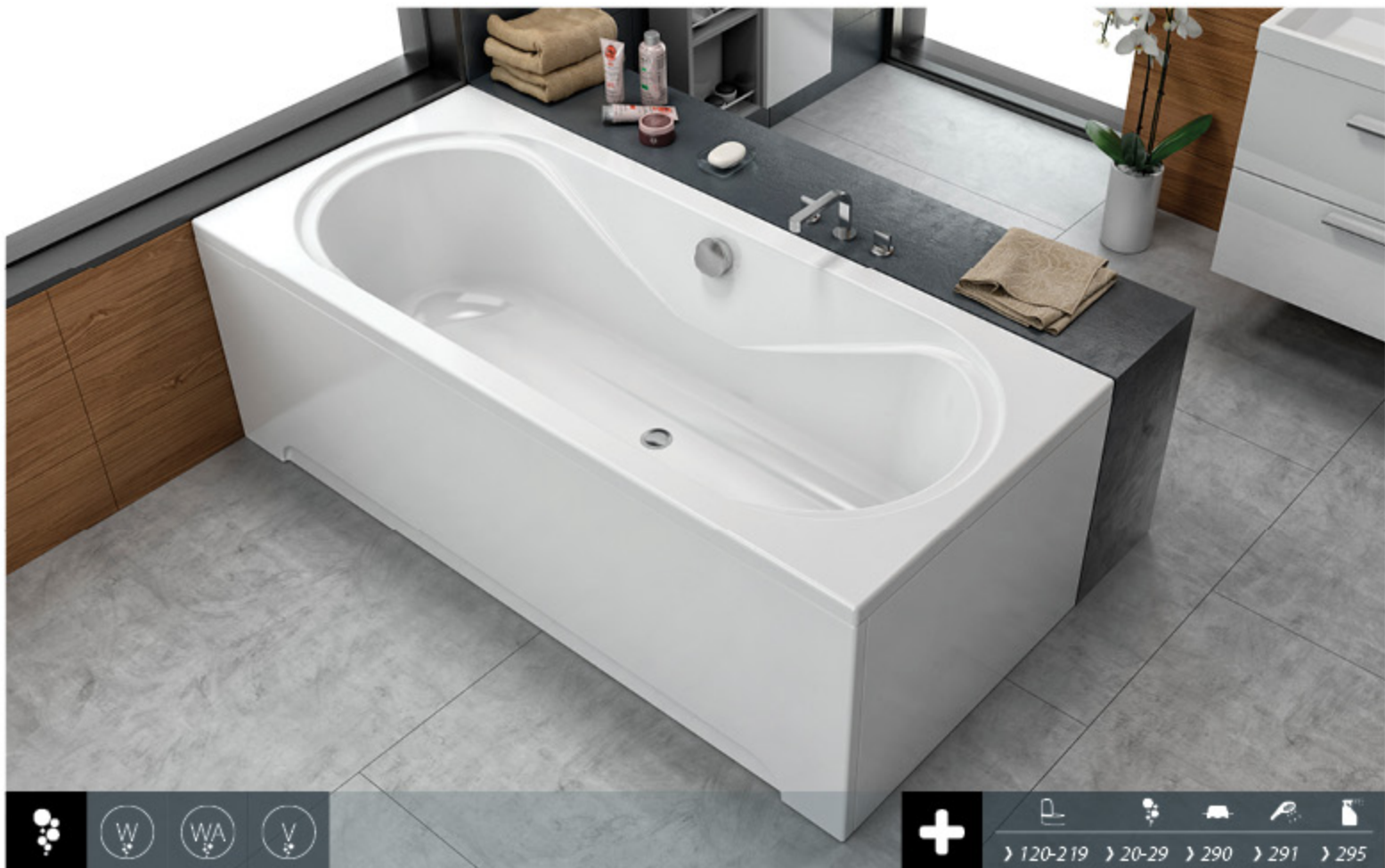

› 120-219 › 20-29 › 290 › 291 › 295



Carmen 180 x 80 / Кармен 180 x 80

- Bathtub, built-in.
- Badewanne, zum Einbau.
- baignoire à encastrer.
- встраиваемая ванна.



		A	B	C	D	Vol.
• •	Carmen 180 x 80	1800	800	1240	520	240 l
• • •	Carmen 180 x 80/O	1800	800	1240	520	240 l



Carmen 180 x 80/O / Кармен 180 x 80/O

- Bathtub with panel.
- Badewanne mit Schürze.
- baignoire avec tablier de façade.
- ванна с панелью.

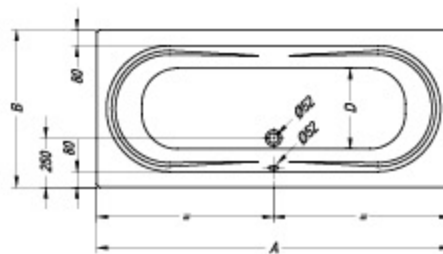

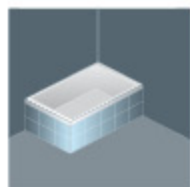

Destiny 180, 170, 160

Дестины 180, 170, 160

- Bathtub, built-in.
- Badewanne, zum Einbau.
- baignoire à encastrer.
- встраиваемая ванна.



Destiny 180/O, 170/O, 160/O

Дестины 180/O, 170/O, 160/O

- Bathtub with panel.
- Badewanne mit Schürze.
- baignoire avec tablier de façade.
- ванна с панелью.

			A	B	C	D	Vol.	
•	•	•	Destiny 180 x 80 (O)	1800	800	1250	540	250 l
•	•	•	Destiny 170 x 75 (O)	1700	750	1150	490	220 l
•	•	•	Destiny 170 x 70 (O)	1700	700	1150	440	205 l
•	•	•	Destiny 160 x 70 (O)	1600	700	1050	440	190 l

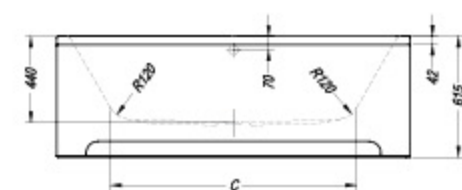
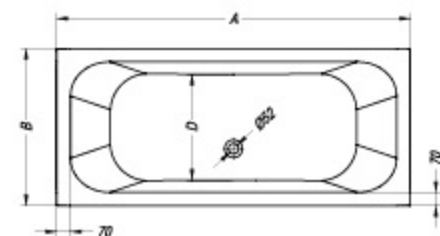



› 120-219 › 20-29 › 290 › 291 › 295



Valis 170 x 80 / Валис 170 x 80

- Bathtub, built-in.
- Badewanne, zum Einbau.
- baignoire à encastrer.
- встраиваемая ванна.



Valis 170 x 80/O / Валис 170 x 80/O

- Bathtub with panel.
- Badewanne mit Schürze.
- baignoire avec tablier de façade.
- ванна с панелью.



• • Valis 170 x 80 (O) A B C D Vol.

	A	B	C	D	Vol.
• • Valis 170 x 80 (O)	1700	800	1180	580	230 l



- Handles
- Handgriffe
- Poignées
- Ручки

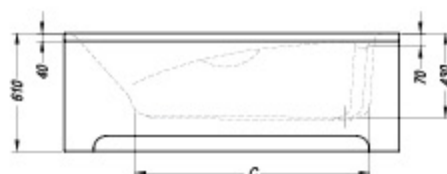
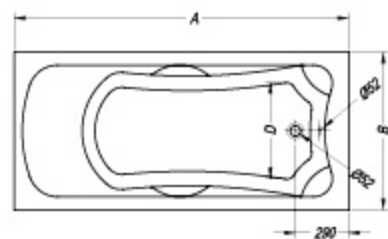



> 120-219 > 20-29 > 290 > 291 > 295

CAROL 170x80/S

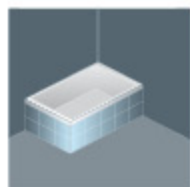

Carol 170x80/S / Карол 170x80 /C

- Bathtub, built-in.
- Badewanne, zum Einbau.
- baignoire à encastrer.
- встраиваемая ванна.



Carol 170x80/SO / Карол 170x80/CO

- Bathtub with panel.
- Badewanne mit Schürze.
- baignoire avec tablier de façade.
- ванна с панелью.



- Handles
- Handgriffe
- Poignées
- сиденье



- seat
- Sitz
- siège
- Ручки

The product is well suited for elderly users.
Das Produkt ist geeignet für ältere Nutzer.
Le produit convient aux utilisateurs âgés.
Изделие подходит для людей пожилого возраста.

P	A	B	Vol.
• Carol 170 x 80/S (O)	1700	800	190 l

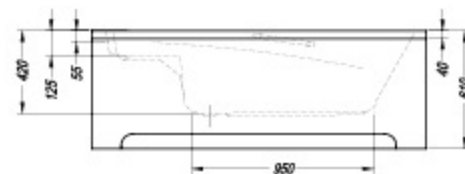
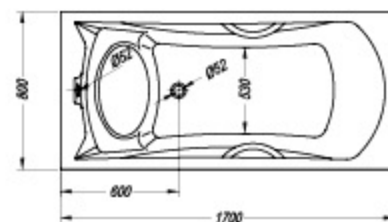

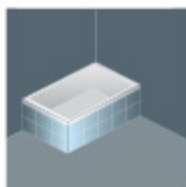

**Evelin bathtub 170, 160, 150, 140 /
Евелин батhtub 170, 160, 150, 140**
- Bathtub, built-in.
- Badewanne, zum Einbau.
- baignoire à encastrer.
- встраиваемая ванна.



**Evelin bathtub 170/O, 160/O, 150/O, 140/O /
Евелин батhtub 170/O, 160/O, 150/O, 140/O**
- Bathtub with panel.
- Badewanne mit Schürze.
- baignoire avec tablier de façade.
- ванна с панелью.



	A	B	C	D	Vol.
• • • Evelin bathtub 170 x 75 (O)	1700	750	1195	505	200l
• • • Evelin bathtub 170 x 70 (O)	1700	700	1195	455	175l
• • • Evelin bathtub 160 x 70 (O)	1600	700	1095	455	160l
• • • Evelin bathtub 150 x 70 (O)	1500	700	1010	455	150l
• • • Evelin bathtub 140 x 70 (O)	1400	700	910	455	135l

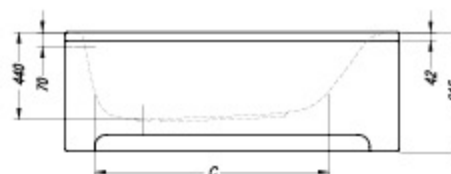
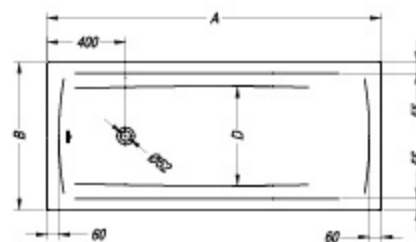



> 120-219 > 20-29 > 290 > 291 > 295

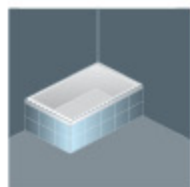

**Tamia 170, 160, 150, 140 /
Тамиа 170, 160, 150, 140**
- Bathtub, built-in.
- Badewanne, zum Einbau.
- baignoire à encastrer.
- встраиваемая ванна.



**Tamia 170/O, 160/O, 150/O, 140/O /
Тамиа 170/O, 160/O, 150/O, 140/O**
- Bathtub with panel.
- Badewanne mit Schürze.
- baignoire avec tablier de façade.
- ванна с панелью.



	A	B	C	D	E	Vol.
• • • Tamia 170 x 75 (O)	1700	750	1290	520	440	230 l
• • • Tamia 170 x 70 (O)	1700	700	1260	460	440	215 l
• • • Tamia 160 x 70 (O)	1600	700	1195	480	430	180 l
• • • Tamia 150 x 70 (O)	1500	700	1100	480	430	170 l
• • • Tamia 140 x 70 (O)	1400	700	1000	480	430	155 l

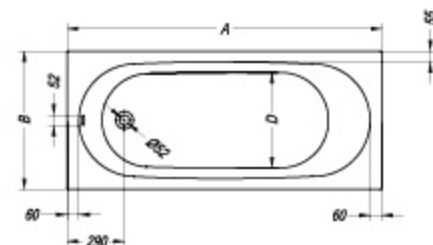









 > 120-219 > 20-29 > 290 > 291 > 295



Tamia 140x70/S / Тамия 140/S

- Bathtub, built-in.
- Badewanne, zum Einbau.
- baignoire à encastrer.
- встраиваемая ванна.



- seat
- Sitz
- siège
- сиденье

P

	A	B	C	D	Vol.
• Tamia 140 x 70/S (O)	1400	700	745	500	135 l



Tamia 140x70/SO / Тамия 140/SO

- Bathtub with panel.
- Badewanne mit Schürze.
- baignoire avec tablier de façade.
- ванна с панелью.

The product is well suited for elderly users.

Das Produkt ist geeignet für ältere Nutzer.

Le produit convient aux utilisateurs âgés.

Изделие подходит для людей пожилого возраста.

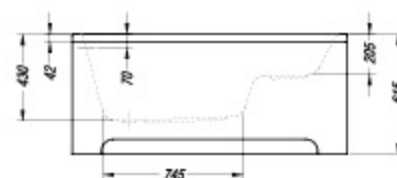
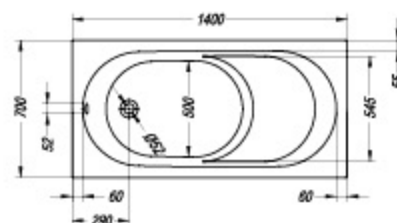

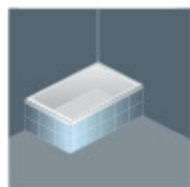

FIGARO 170, 160, 150

**Figaro 170, 160, 150 / Фигаро 170, 160, 150**

- Bathtub, built-in, shallow.
- Flache badewanne, zum Einbau.
- baignoire à encastrer, peu profonde.
- встраиваемая ванна, мелкая.

**Figaro 170/O, 160/O, 150/O / Фигаро 170/O, 160/O, 150/O**

- Bathtub with panel.
- Badewanne mit Schürze.
- baignoire avec tablier de façade.
- ванна с панелью, мелкая.

The product is well suited for elderly users.

Das Produkt ist geeignet für ältere Nutzer.

Le produit convient aux utilisateurs âgés.

Изделие подходит для людей пожилого возраста.

	A	B	C	D	Vol.
• • Figaro 170 x 75(O)	1700	750	1320	520	145 l
• Figaro 160 x 80	1600	750	1320	520	145 l
• • Figaro 150 x 70(O)	1500	700	1110	500	120 l

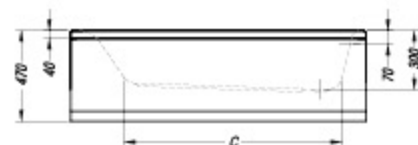
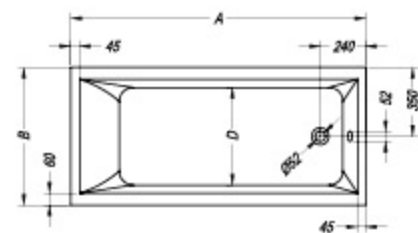

Adela 160, 150 /
Адела 160, 150

- Bathtub, built-in.
- Badewanne, zum Einbau.
- baignoire à encastrer.
- встраиваемая ванна.

Adela 160/O, 150/O /
Адела 160/O, 150/O

- Bathtub with panel.
- Badewanne mit Schürze.
- baignoire avec tablier de façade.
- ванна с панелью.



	A	B	C	D	Vol.
• • Adela 160 x 70 (O)	1600	700	1170	440	220 l
• • Adela 150 x 70 (O)	1500	700	1070	440	200 l

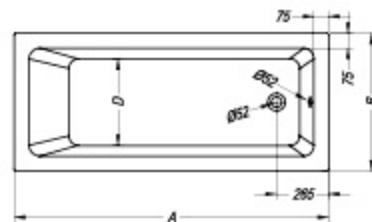

Accordo 140 x 70 / Аккордо 140 x 70

- Bathtub, built-in.
- Badewanne, zum Einbau.
- baignoire à encastrer.
- встраиваемая ванна.



Accordo 140 x 70/O / Аккордо 140 x 70/O

- Bathtub with panel.
- Badewanne mit Schürze.
- baignoire avec tablier de façade.
- ванна с панелью.

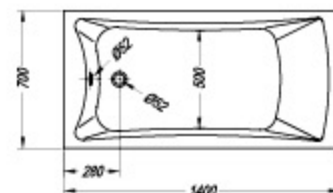

	A	B	Vol.
• • Accordo 140 x 70 (O)	1400	700	180 l

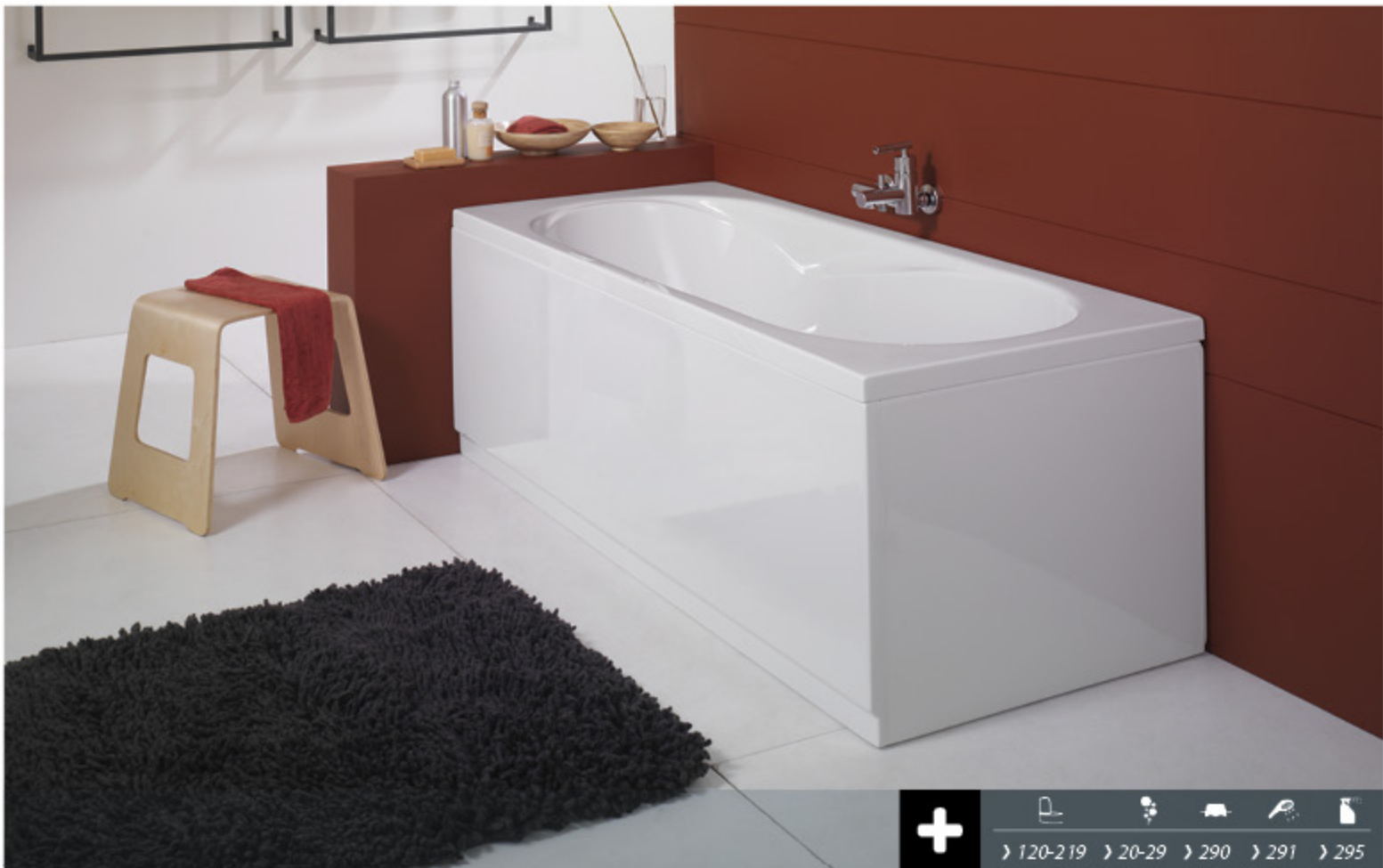



Ester 130 x 70 / Эстер 130 x 70

- Bathtub, built-in.
- Badewanne, zum Einbau.
- baignoire à encastrer.
- встраиваемая ванна.



Ester 130 x 70/O / Эстер 130 x 70/O

- Bathtub with panel.
- Badewanne mit Schürze.
- baignoire avec tablier de façade.
- ванна с панелью.



	A	B	Vol.
• • Ester 130 x 70 (O)	1300	700	130l

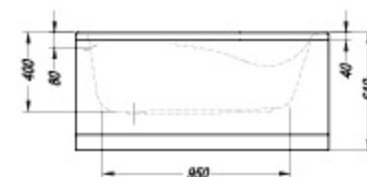
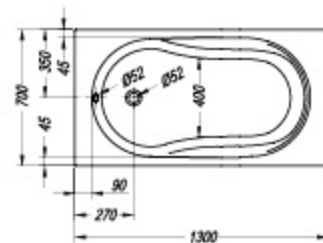







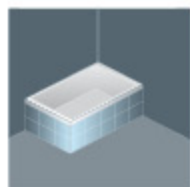

 > 120-219 > 20-29 > 290 > 291 > 295



Cavatina 120x70/S / Каватина 120x70 /C

- Bathtub, built-in.
- Badewanne, zum Einbau.
- baignoire à encastrer.
- встраиваемая ванна.



Cavatina 120x70/SO / Каватина 120x70/CO

- Bathtub with panel.
- Badewanne mit Schürze.
- baignoire avec tablier de façade.
- ванна с панелью.



- seat
- Sitz
- siège
- сиденье

The product is well suited for elderly users.
 Das Produkt ist geeignet für ältere Nutzer.
 Le produit convient aux utilisateurs âgés.
 Изделие подходит для людей пожилого возраста.



	A	B	Vol.
• Cavatina 120x70/S (O)	1200	700	115 l

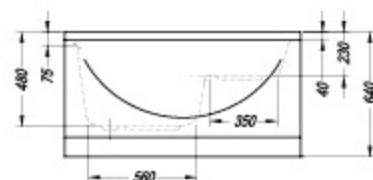
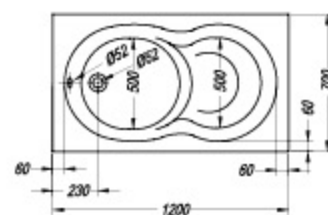

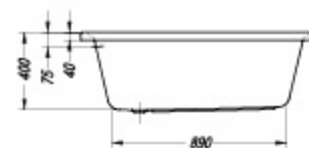
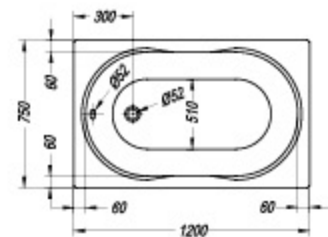

Boogie 120 x 75 / Буги 120 x 75

- Bathtub, built-in.
- Badewanne, zum Einbau.
- baignoire à encastrer.
- встраиваемая ванна.



A B Vol.

• •	Boogie 120x75	1200	750	120l
-----	---------------	------	-----	------

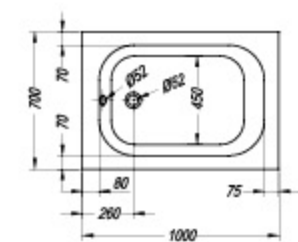

> 120-219 > 20-29 > 290 > 291 > 295

Mini 100 x 70 / Мини 100 x 70

- Bathtub, built-in.
- Badewanne, zum Einbau.
- baignoire à encastrer.
- встраиваемая ванна.

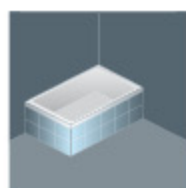

A B Vol.

• •	Mini 100x70	1000	700	110l
-----	-------------	------	-----	------